



# USER'S MANUAL

A photograph of a silver LED TV, shown from a low angle that emphasizes its slim profile. The TV is set against a dark grey background.

## LED TV FL28105

Read this manual carefully and retain it for future reference



# TABLE OF CONTENTS

1. Safety instructions .....	3
2. TV ASSEMBLY AND CONNECTION .....	5
2.1 TV Bracket Assembly .....	5
2.2 TV Button and Terminal Interface .....	6
2.3 External Device Connection Diagram .....	7
2.4 Installing and Connecting the TV .....	8
2.5 TV Stand Installation Instruction .....	8
3. REMOTE CONTROL .....	9
4. TV OPERATION AND SYSTEM SETUP .....	11
4.1 Picture Menu .....	13
4.2 SOUND Menu .....	15
4.3 APPLICATIONS .....	17
4.4 PREFERENCES .....	23
4.5 SETUP .....	25
4.6 HOTEL MODE SETTINGS .....	28
4.7 How to user Record .....	30
4.8 How to user Time shift .....	35
5. MEDIA OPERATION .....	39
5.1 Photo .....	40
5.2 Movie .....	41
5.3 Music .....	42
5.4 Setup .....	43
6. Troubleshooting .....	44



# 1. Safety instructions

Welcome



Congratulations! You now own one of the most state of the art and technologically advanced high definition television products available. In order to set it up as easy as possible, we would like to familiarize you with the features and functions of this special product. Please read this user's manual carefully and thoroughly and keep in a safe place for future reference.

We thank you for your business and hope you enjoy this product.

## Caution

	
<b>RISK OF ELECTRIC SHOCK DO NOT OPEN</b>	
<p>CAUTION: TO REDUCE THE RISK OF ELECTRIC SHOCK, DO NOT REMOVE COVER (OR BACK), NO USER-SERVICEABLE PARTS INSIDE. REFER SERVICING TO QUALIFIED SERVICE PERSONNEL</p>	

<p><b>CAUTION</b> -TO PREVENT DAIMAGE WHICH MAY RESULT IN FIRE OR SHOCK HAZARD -DO NOT EXPOSE THIS APPLIANCE TO RAIN OR MOISTURE. -SHOCK HAZARD - DO NOT OPEN</p>
---

	<p>This symbol is intended to alert the user to the presence of not insulated "dangerous voltage" within the product's enclosure that may be of sufficient magnitude to constitute a risk of electric shock to persons.</p>
	<p>This symbol is intended to alert the user to the presence of important operating and maintenance (servicing) instructions in the literature accompanying the appliance.</p>

<p><b>CAUTION</b> These servicing instructions are for use by qualified service personnel only. To reduce the risk of electric shock, do not perform any servicing other than that contained in the operating instruction unless you are qualified to do so.</p>
--

<p><b>CAUTION</b> The stand is intended for use only with this TV. Using it with other apparatus may result in instability causing possible injury.</p>
---

<p><b>WARNING</b> - The apparatus shall not be exposed to dripping or splashing and no objects filled with liquids, such as vases, shall be placed on the apparatus. -This is a Class B product. In a domestic environment this product may cause radio interference in which case the user may be required to take adequate measures. To reduce the risk of fire and electric shock, do not expose this product to rain or moisture.</p>
---

<p><b>FCC NOTICE</b> This device has been tested and found to comply with the limits for a Class B device, pursuant to Part 15 of the FCC Rules. These limits are designed to provide reasonable protection against harmful interference in home environment as well as in a commercial, industrial or business environment. This equipment can generate, use and emit radio frequency energy and, if not installed and used in accordance with the instructions, may cause harmful interference to radio communications. However, there is no guarantee that interference will not occur in a particular installation. If this equipment does cause harmful interference to radio or television reception, which can be determined by tuning the equipment off and on, the user is encouraged to try to correct the interference by one or more of the following measures:</p> <ul style="list-style-type: none"><li>- Reorient or relocate the receiving antenna.</li><li>- Increase the separation between the equipment and receiver.</li><li>- Connect the equipment into an outlet on a circuit which is different form that to which the receiver is connected.</li><li>- Consult the dealer or an experienced radio/TV technician for help.</li><li>- Changes or modifications not expressly approved by the party for compliance could void the user's authority to operate the equipment.</li><li>- Connecting of peripherals requires the use of grounded shielded signal cables.</li></ul>
--

# Important Safety Precautions

Always be careful when using your television. To reduce the risk of fire, electrical shock, and other injuries, keep these safety precautions in mind when installing, using, and maintaining your television.

- Read these instructions and keep them in a safe place.
- Heed all warnings.
- Follow all instructions.
- Do not use this apparatus near water.
- Do not block any of the ventilation openings.
- Install it in accordance with the manufacturer's instructions.
- Do not install near any heat sources such as radiators, heat registers, stoves, or other apparatus (including amplifiers) that produce heat.
- Do not defeat the safety purpose of the polarized or grounding type plug. A polarized plug has two blades with one wider than the other. A grounding type plug has two blades and a third grounding prong. The wide blade or the third prong is provided for your safety. When the provided plug does not fit into your outlet, consult an electrician for replacement of the obsolete outlet.
- Protect the power cord from being walked on or pinched particularly at plugs, convenience receptacles, and the point where they exit from the television.
- Only use the attachments/accessories specified by the manufacturer.
- Use only with a cart, stand, tripod, bracket, or table specified by the manufacturer, or sold with the television. When a cart is used, use caution when moving the cart/apparatus combination to avoid injury from tip-over.
- Unplug this television during lightning storms or when it is not going to be used for long periods of time.
- Refer all servicing to qualified service personnel. Servicing is required when the television has been damaged in any way, i.e. when the power supply cord or plug is damaged, liquid has been spilled or objects have fallen into the unit, the Television has been exposed to rain or moisture, does not operate normally, or has been dropped.
- Clean only with a lint free cloth.



## 2. TV ASSEMBLY AND CONNECTION

### 2.1 TV Bracket assembly

#### Fix the TV on the wall

1. First, put the TV on a table smoothly and put a soft cloth on the table to avoid scratching the screen.
2. Use a screw driver to take off the screws which are fixed on the bottom stand (in the direction of the arrow, refer to photo1). Then, remove the bottom stand (please take off the screws and the bottom stand carefully).
3. Use a bracket which can fixed on the wall according to the size of the arrow direction of photo 2 and photo 3.
4. Drill four holes properly on the wall (the size is only for reference) and put four screws into them (optional parts).
5. As per step 4, use the screwdriver to fasten the screws on the back of the TV and then hang the TV on the wall.

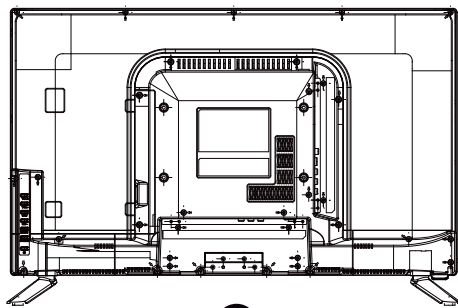

1

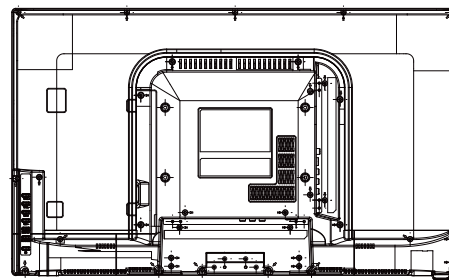

2

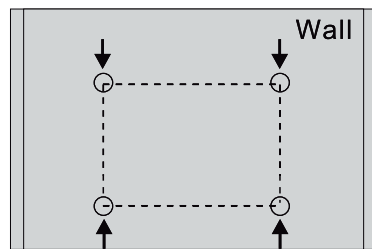

3

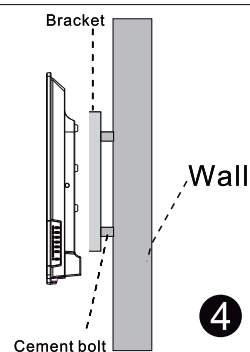

4

#### Note:

1. The bracket fixed on the wall is an optional part.
2. When you assemble the TV, there should be no other objects in front and around it. Please keep a distance from other objects.
3. When assembling the TV, please fix it firmly in order to avoid any danger.
4. The fixing picture is only for reference.
5. Please follow the instructions of the user manual about the bracket assembly for fixing the TV.
6. Attach the mounting bracket from the VESA compatible wall mounting kit.

## 2.2 TV buttons and terminal interface

### TV buttons

Note: The following picture is only functional schematic and the actual position and the arrangement of different models may vary.

**SOURCE MENU CH+ CH- VOL+ VOL- POWER**

**SOURCE:** External signal input selection.

**MENU:** Display main MENU and confirm MENU item selection.









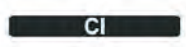
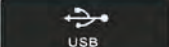

**CH+/-:** Selecting channel.

**VOL+/-:** Adjusting volume.

**POWER:** Turn ON/OFF Power

### Terminal Interface

Note: The following are the various terminal interfaces, the actual position and arrangement in different models may vary.

	<b>AV input</b> External AV Signal Input And Relevant Right/Left Sound Channel		<b>EARPHONE output</b> When earphones are plugged in, speakers are disabled
	<b>CI SLOT</b> The card reader input CI (common interface) this requires CAM (conditional access module) used for pay TV.		<b>USB input</b> Connect a USB device here to play its media files or to record programs via the PVR function.
	<b>Y Pb Pr input</b> Connect to the composite terminal of your DVD/VCR (Some models without this interface)		<b>SCART input</b> standard, it supports composite and RGB signal input. It is a connection for European (Some models without this interface)
	<b>HDMI input</b> Digital signal input from HDMI video connector.		<b>COAXIAL</b> Connect the SPDIF receiver.
	<b>ANT 75</b> Connect the antenna/cable tv input (75/VHF/UHF)		
	<b>VGA input</b> PC analog signal input		
	<b>PC AUDIO INPUT</b> VGA input and audio input when VGA input		

## 2.3 External device connection diagram

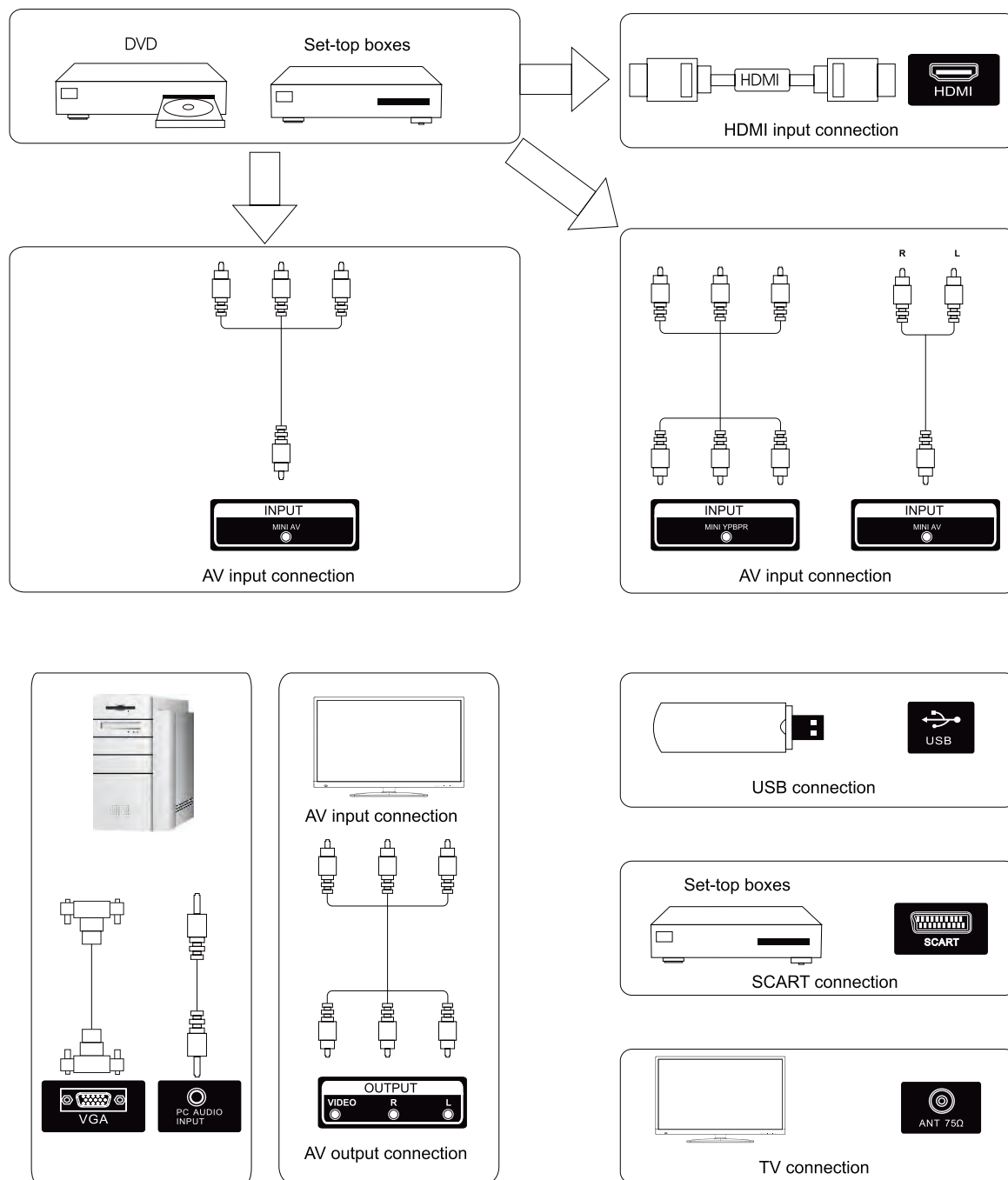

## 2.4 Installing and connecting the TV

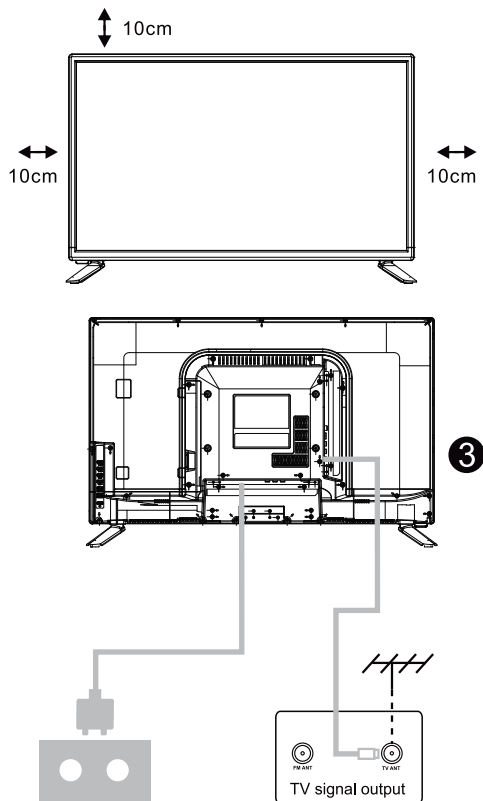

### Setup your TV

Place your TV in a firm place which can bear the weight of the TV. To avoid danger, please don't expose the TV near water or heating object (such as light, candle, heating machine) and do not block the ventilation at the back of the TV.

### Connect the antenna and power cables

1. Connect the antenna cable to the antenna socket on the back of the TV.
2. Plug the power cord of the TV (AC 100-240V~ 50/60Hz).

### Turn on the TV

3. Press the power button of the TV and the indication light will turn to green. If it is on standby mode (the light is red), press the power button on the remote control to turn on the TV.

Note: For reference purposes only

## 2.5 TV Stand installation instructions

1. Open the carton and remove the TV, the various accessories and the stand (some models do not have a stand).
2. To avoid damage to the TV, cover it with a soft mattress, put it on a table, face down on the mattress. The base of the neck is fixed on the TV with screws.
3. Screw the stand and connect it the TV.
4. The installation is complete.

**Note:** The diagram is for reference purposes only

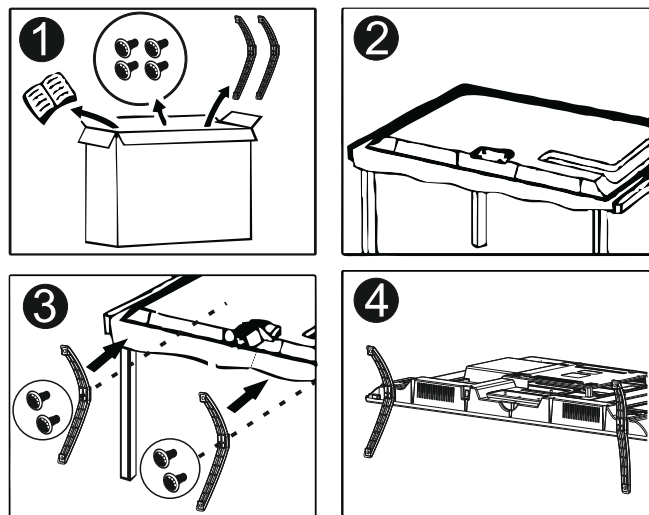

## 3. Remote Control

1. **POWER**: Sets your TV to power on or standby mode.
2. **MUTE**: Press to mute the sound. Press again or press VOL+ to unmute.
3. **0-9**: Press 0~9 to select a TV channel directly while watching TV. The channel will change after 2 seconds. Applicable for entering page number in teletext mode and so on.
4. **DTV/ATV**: Switch between analog and digital TV.
5. **↶**: Return to the previous viewed program.
6. **S.MODE**: Press to cycle through the different sound settings.
7. **SLEEP**: Select the amount of time before TV turns itself off automatically.
8. **EPG**: Launches the EPG.
9. **P.MODE**: Press to cycle through the different picture settings.
10. **MENU**: Allows you to navigate to the on-screen menus.
11. **SOURCE**: Opens the main menu, press to list the sources.
12. **▲▼◀▶ ENTER**: Allows you to navigate the on-screen menu and adjust the system settings to your preferences.
13. **EXIT**: Exits from the menu or sub-menu and cancels the function in process (if applicable).
14. **DISPLAY**: Press to display the source and channel's info.

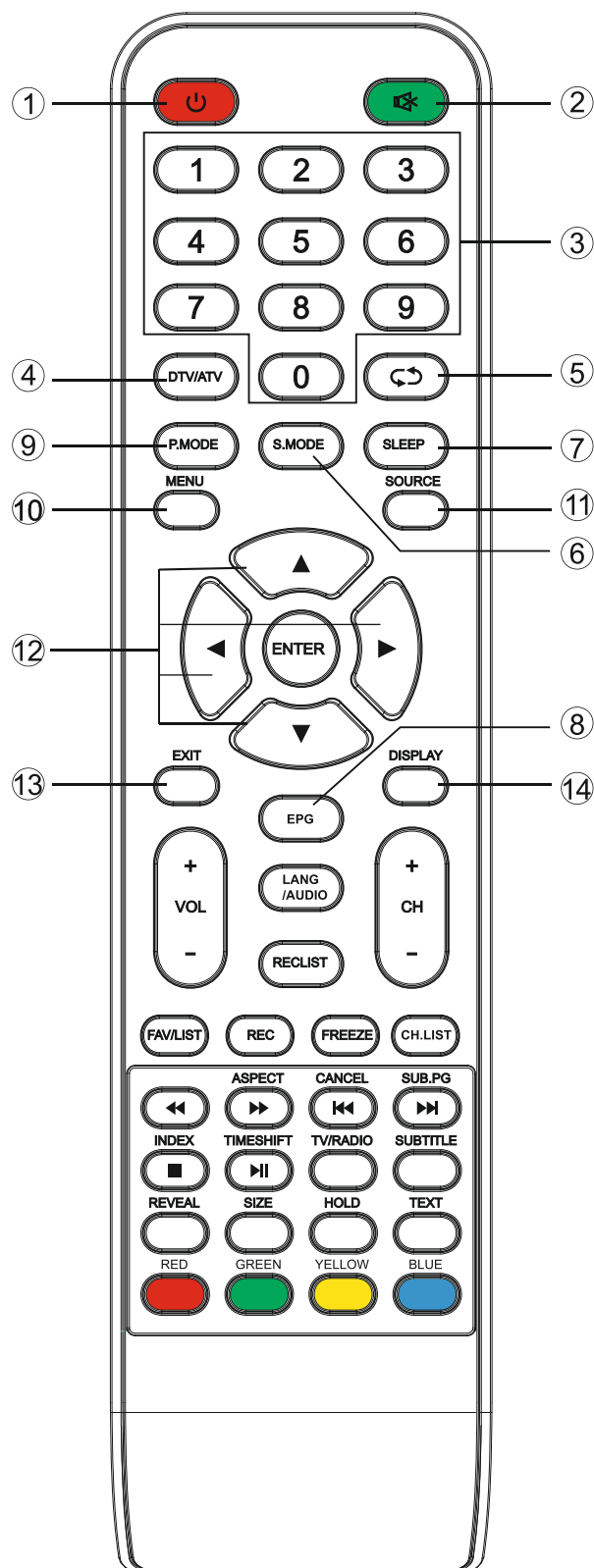

### Battery Installation:

Remove the battery compartment lid on the rear of the remote control by sliding the lid down, then off. Put two AAA batteries inside the battery compartment with their + and – ends aligned as indicated. Do not mix old and new batteries or different types of batteries. Slide the lid until you hear it click into place.

15. **VOL+/VOL-**: Press to increase/ decrease the sound level.
16. **TV/RADIO**: When watching a channel, allows you to switch between TV and Radio modes.
17. **◀◀**: Fast reverse in PVR or Media Player mode.
18. **TIME SHIFT**: 1. DTV channel time shift function. Play on PVR or Media Player mode.
19. **CANCEL**: 1. When a page is selected in the text mode, it may take some time before it becomes available. Pressing the CANCEL key will return to the TV mode. When the required page is found, the page number will appear at the top of the TV picture. Press the CANCEL key to return to the text mode for you to browse this page. 2. Previous chapter in PVR or Media Player mode.
20. **INDEX**: 1. Request the Index page in teletext mode. 2. Previous chapter in PVR or Media Player mode.
21. **SIZE**: Change the size of display in Teletext mode.
22. **REVEAL**: Reveal or hide the hidden words.
23. **COLOR BUTTONS**: Teletext switch of the analog parts, the items selection in the menu of the digital parts and the MHEG5 function in the DVB menu.
24. **CH+/CH-**: Press to scan through channels.
25. **FAV/LIST**: Press to open the favorite list. Then you can select a favorite channel.
26. **ASPECT**: 1. Select picture scale. 2. Fast forward in PVR or media player mode.
27. **FREEZE**: Press to freeze the picture.
28. **SUB.PG**: 1. Press to access a sub-page. Next chapter in PVR or media player mode.
29. **SUBTITLE**: Shows and sets the language of current DTV.
30. **HOLD**: On or off for current page display.
31. **TEXT**: Switches the teletext on and off.
32. **RECLIST**: Shows the recorded list.
33. **REC**: Record begin in PVR mode.
34. **CH.LIST**: Shows the channel list.
35. **LANG/AUDIO**: Press to search the NICAM mode or language option.

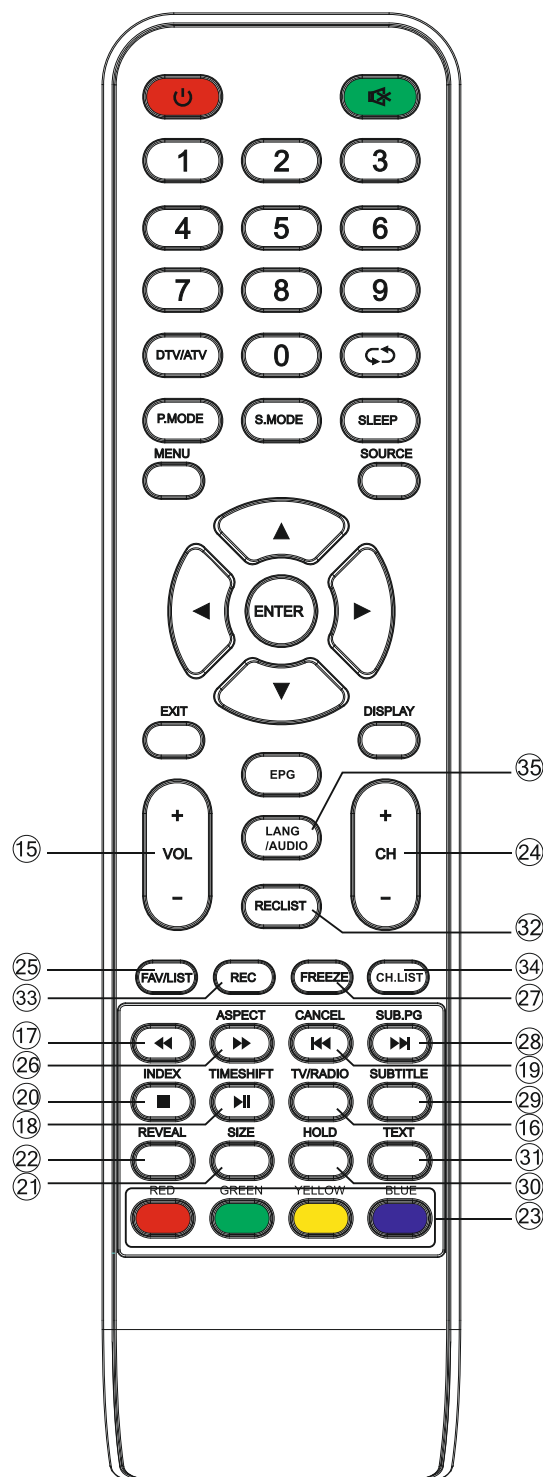

#### Using the Remote Control:

Unless stated, the remote control can operate all the features of the TV.

Always point the remote control directly at the remote sensor in front of the TV.

## 4. TV OPERATION AND SYSTEM SETUP

### SELECT INPUT SOURCE



Press **SOURCE** button to display the input source list.

Press **▲/▼** button to select the input source you want to watch.

Press **ENTER** button to enter the input source.



- Press **MENU** button to display the MAIN OSD MENU.
- Press ▲/▼ button to select the MENU you want.
- Press **ENTER** button or ► button to enter the sub menu, and press ◀ button to return back to the previous menu.
- Press ▲/▼ button to select the option and then press **ENTER** button or ► button to enter the submenu, press ◀/▶ button to adjust the value or press ◀/▶ button to select within the submenu.
- You can press **MENU** button to save and return back to the previous menu, and press **EXIT** button to exit from the menu.

Press **INFO** button on the remote control to display program information.



1. Current program number.
2. The NICAM mode of the current program.
3. The sound system of the current channel can be changed in the **Analog Manual Search** menu.

## 4.1 Picture Menu

The picture is for a reference only; the actual items are the ones appearing in your TV.

Press **TV MENU** button to display the main menu.

Press **▲/▼** button to select **Picture** in the main menu, and then press **ENTER** button to enter.

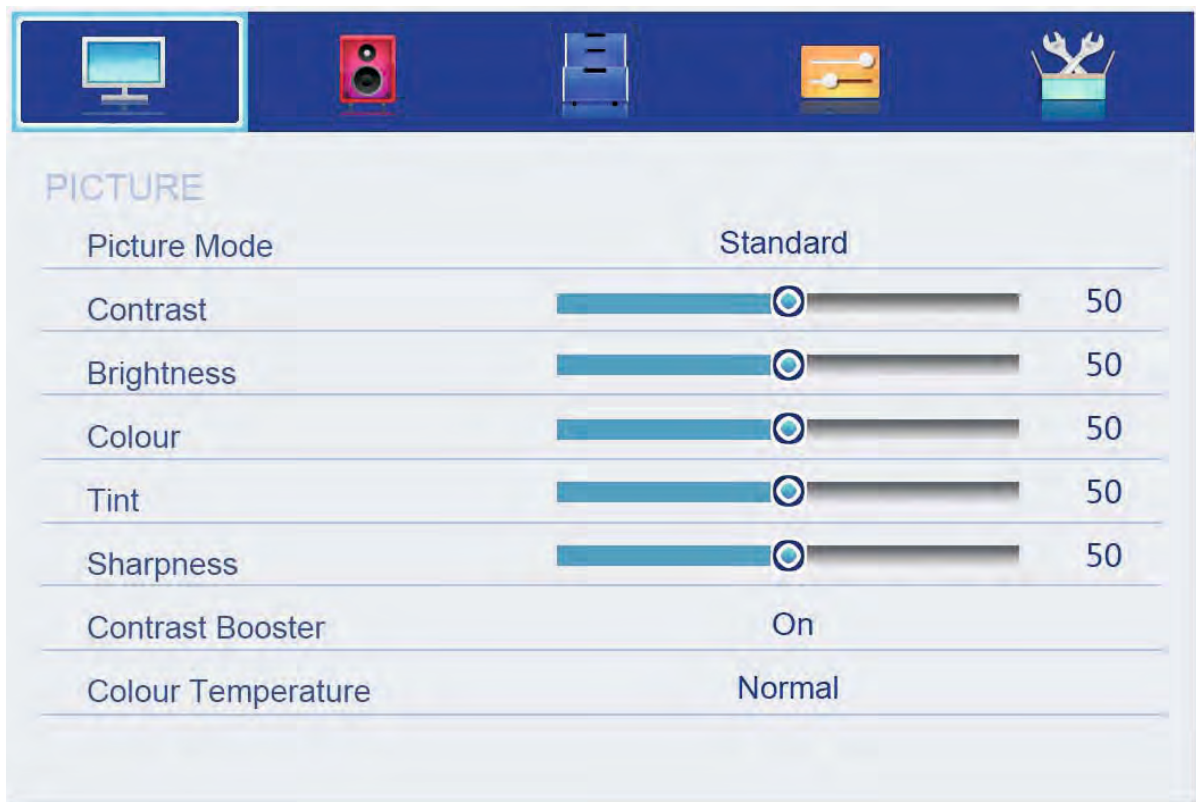

1. Press **▲/▼** button to select the option that you want to adjust in the Picture menu, and then press **ENTER** button or **▶** button to enter.
2. Press **◀/▶** button to adjust or press **▲/▼** button to select, and press **ENTER** button to select the submenu.
3. After finishing your adjustment, press **MENU** button to save and return back to the previous menu, and press **EXIT** button to exit from the menu.

### 4.1.1 Picture Mode

Press **▲/▼** button to select Picture Mode, then press **ENTER** button to enter and press **◀/▶** button to select. (Available Picture Modes: User, Dynamic, Standard, Mild)

You only can change the values of brightness, contrast, sharpness, color, when the picture is in User mode.

**TIPS:** You can press **P-MODE** button on the remote control again and again to change the picture mode directly.

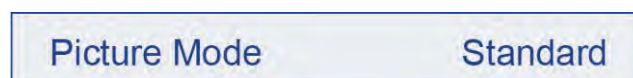

#### 4.1.2 Contrast

Press ▲/▼ button to select Contrast, then press **ENTER** button to enter and press ◀/▶ button to adjust. Then press **MENU** button to return back to the previous menu directly.

#### 4.1.3 Brightness

Press ▲/▼ button to select Brightness, then press **ENTER** button to enter and press ◀/▶ button to adjust. Then press **MENU** button to return back to the previous menu directly.

#### 4.1.4 Colour

Press ▲/▼ button to select Colour, then press **ENTER** button to enter and press ◀/▶ button to adjust. Then press **MENU** button to return back to the previous menu directly.

#### 4.1.5 Tint

Press ▲/▼ button to select Tint, then press **ENTER** button to enter and press ◀/▶ button to adjust. Then press **MENU** button to return back to the previous menu directly.

#### 4.1.6 Sharpness

Press ▲/▼ button to select Sharpness, then press **ENTER** button to enter and press ◀/▶ button to adjust. Then press **MENU** button to return back to the previous menu directly.

#### 4.1.7 Contrast Booster

Press ▲/▼ button to select Contrast Booster, then press **ENTER** button to enter and press ◀/▶ button to select On or Off. Then press **MENU** button to return back to the previous menu directly.

#### 4.1.8 Colour Temperature

Press ▲/▼ button to select **Colour Temperature**, then press **ENTER** button to enter and ◀/▶ button to select Standard, Cool, Warm.

#### 4.1.9 DNR

Press ▲/▼ button to select **DNR**, and then press **ENTER** button to enter and ◀/▶ button to select Off, Low, Middle, High.

#### 4.1.10 Reset

Press ▲/▼ button to select **Reset**, then press **ENTER** button to enter the confirmation menu, and then choose **OK** to reset the value.

## 4.2 SOUND Menu

The picture is for reference only; the actual items are the ones appearing in your TV.

Press **MENU** button to display the main menu.

Press **▲/▼** button to select **Sound** in the main menu, and then press **ENTER** button or **▶** button to enter.

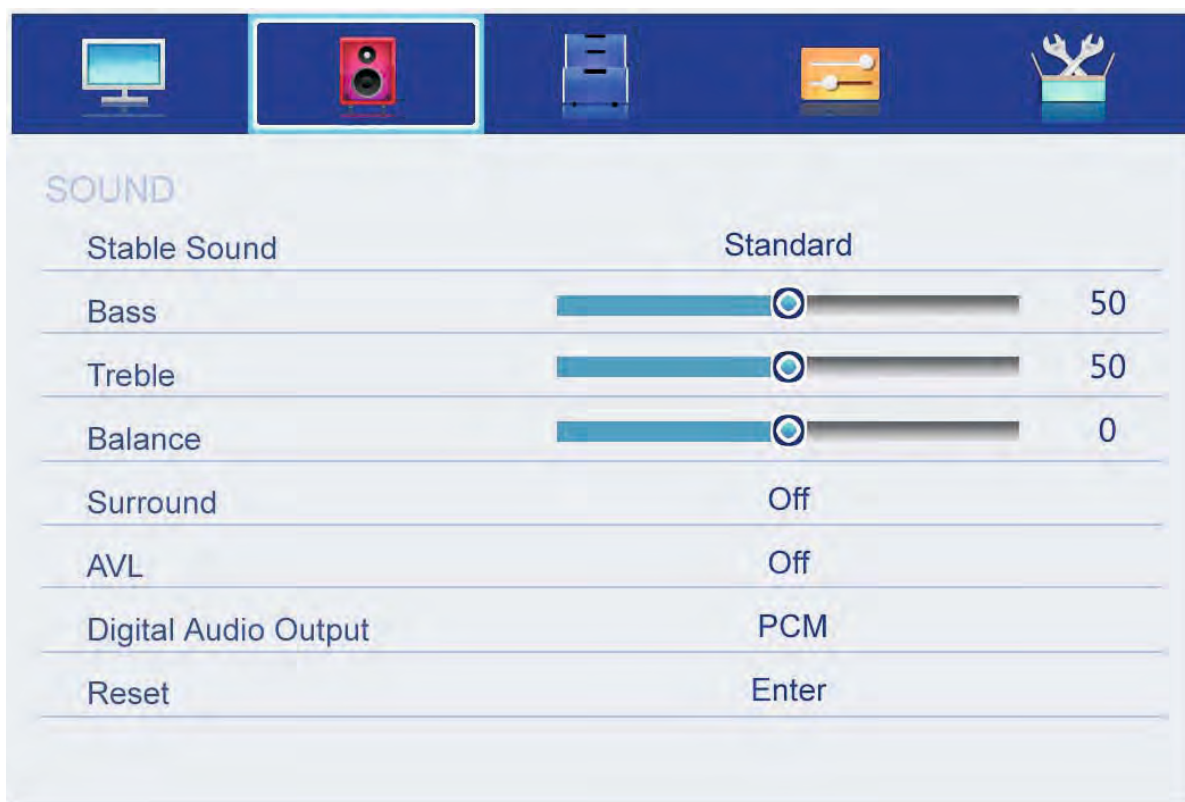

1. Press **▲/▼** button to select the option that you want to adjust in the Sound menu, then press **ENTER** button to enter.
2. Press **◀/▶** button to adjust or press **▲/▼** to select, and press **ENTER** button to select submenu.
3. After finishing your adjustment, Press **MENU** button to save and return back to the previous menu, or press **EXIT** button to exit from the menu.

### 4.2.1 Sound mode

Press **▲/▼** button to select **Sound mode**, and then press **ENTER** button to enter. Then press **◀/▶** button to select. (Available Sound modes: User, Standard, Music, Movie).

You can change the value of bass and treble, Balance and EQ, when the sound is in User mode.

**TIPS:** You can press **S-MODE** button on the remote control to change the Sound Mode directly.

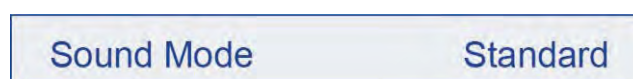

### 4.2.2 Bass

Press **▲/▼** button to select Bass, then press **ENTER** or **▶** button to enter and press **◀/▶**

button to adjust. It can only be adjusted under user mode. Then press **MENU** button to return back to the previous menu directly.

#### 4.2.3 Treble

Press ▲/▼ button to select **Treble**, then press **ENTER** button to enter and press ◀/▶ button to adjust. It can only be adjusted under user mode. Then, press **MENU** button to return back to the previous menu directly.

#### 4.2.4 Balance

Press ▲/▼ button to select **Balance**, then press **ENTER** button to enter and press ◀/▶ button to adjust. Then press **MENU** button to return back to the previous menu directly.

#### 4.2.5 Surround

Press ▲/▼ button to select **Surround**, and then press **ENTER** button to enter and press ◀/▶ button to select ON or OFF.

#### 4.2.6 AVL

Press ▲/▼ button to select **AVL**, and then press **ENTER** button to enter and press ◀/▶ button to select ON or OFF.

#### 4.2.7 Digital Audio Output

Press ▲/▼ button to select **Digital Audio Output**, then press **ENTER** button to enter and press ◀/▶ button to select.

(Available SPDIF modes: OFF, PCM, AUTO)

Then press **ENTER** button or ▶ button to enter and press ◀/▶ button to adjust, then press **MENU** button to return back the previous menu directly.

#### 4.2.8 Reset

Press ▲/▼ button to select **Reset**, then press **ENTER** button to enter RESET menu.

## 4.3 APPLICATIONS

The picture is for a reference only; the actual items are the ones appearing in your TV.

Press **MENU** button to display the main menu.

Press **▲/▼** button to select **APPLICATIONS** in the main menu, and then press **ENTER** button to enter.

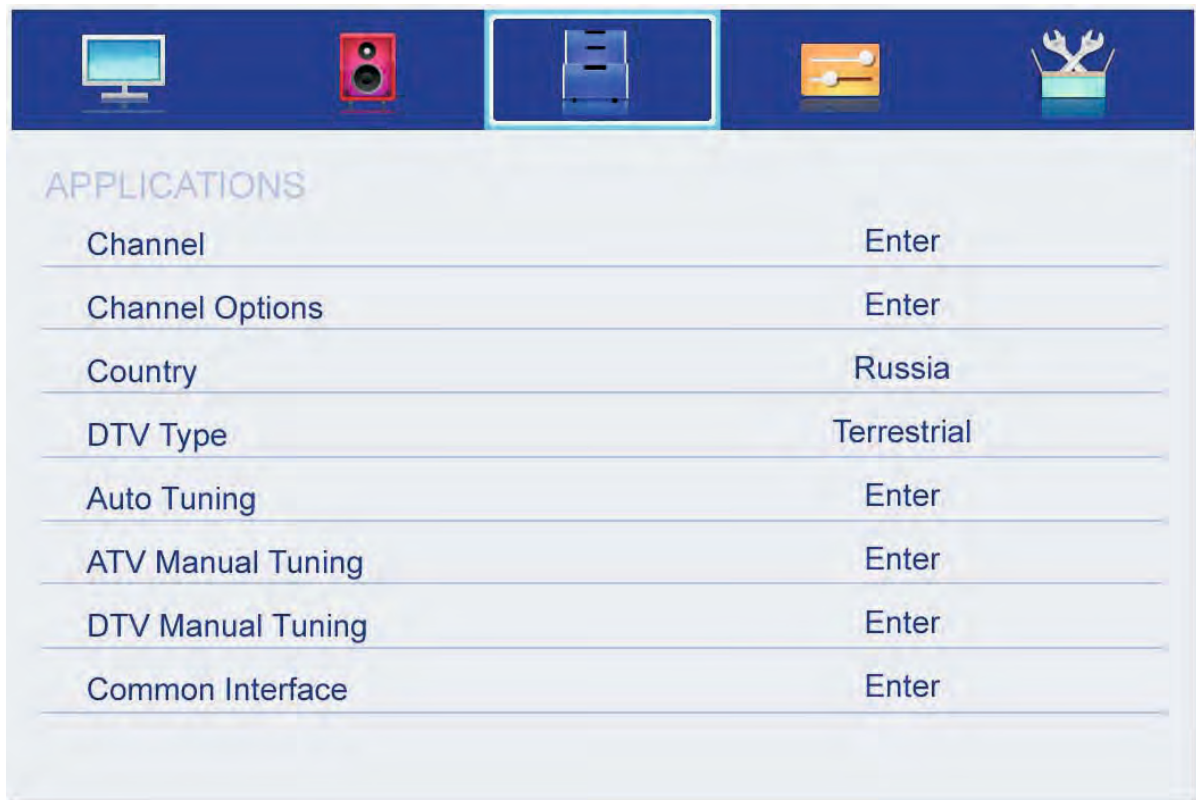

1. Press **▲/▼** button to select the option that you want to adjust in the **APPLICATIONS** menu, and then press **ENTER** button to enter.
2. Press **◀/▶** button to select and press **ENTER** button to select the submenu.
3. After finishing your adjustment, press **MENU** button to save and return back to the previous menu, or press **EXIT** button to exit from the menu.

### 4.3.1 Channel

Press ▲/▼ button to select **Channel**, and then press **ENTER** button to play the channel selected. The menu will appear as follows:

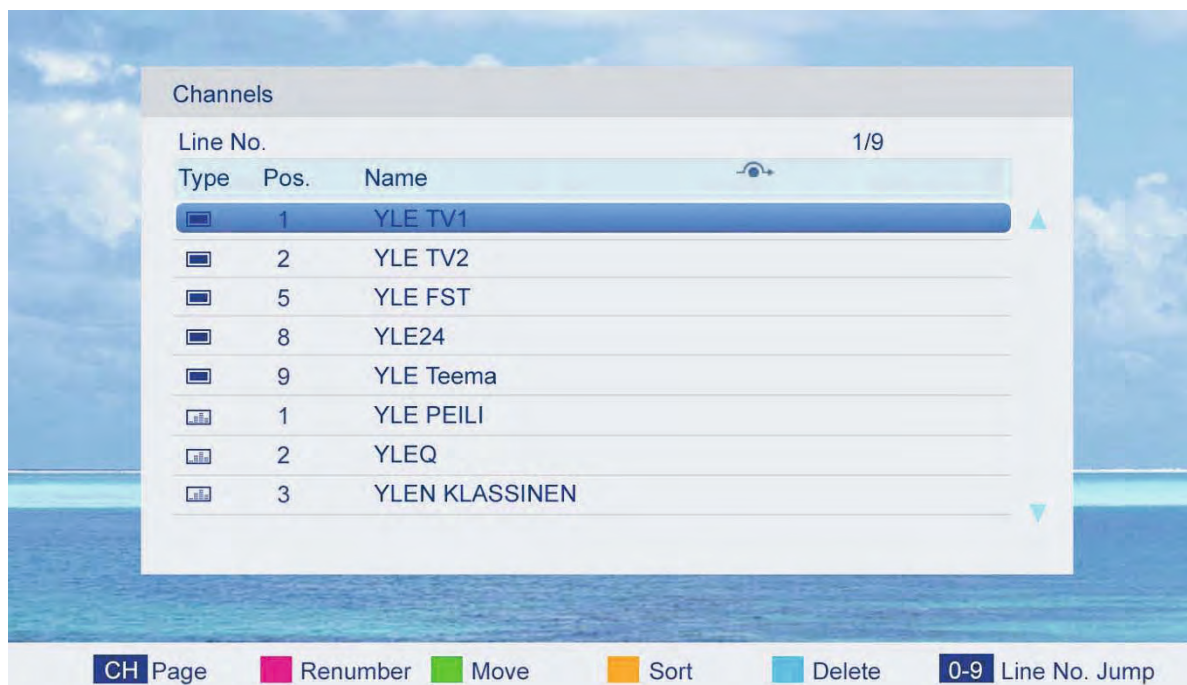

Key Description:

**CH** button: Press CH+ or CH- to turn the page.

**RED** button: Press this button to modify the channel number.

**GREEN** button: Press this button to move the channel down.

**YELLOW** button: Press this button to restore the order of the default channel.

**GREEN** button: Press this button to delete the selected channel.

**0-9** button: Press these buttons to jump to the appropriate channel by entering a different channel number.

### 4.3.2 Channel Options

Press ▲/▼ button to select **Channel Options**, and then press **ENTER** button to go to the channel List menu. The menu will appear as follows:



Key Description:

**CH** button: Press CH+ or CH- to turn the page.

**RED** button: Press this button to set the favorites channels.

**GREEN** button: Press this button to lock a channel.

**YELLOW** button: Press this button to skip a channel. If the channel is already skipped, press **YELLOW** button to cancel skip.

### 4.3.3 Country

Press ▲/▼ button to select **Country**, and then press ◀/▶ button to select the area you live.

### 4.3.4 DTV Type

Press ▲/▼ button to select **DTV Type**, then press ◀/▶ button to select.

(Available DTV Type: Cable, Terrestrial)

### 4.3.5 Auto Tuning

Press ▲/▼ button to select **Auto Tuning**, and then press **ENTER** button to enter

(When the System Lock is on, please enter the PIN code to unlock).

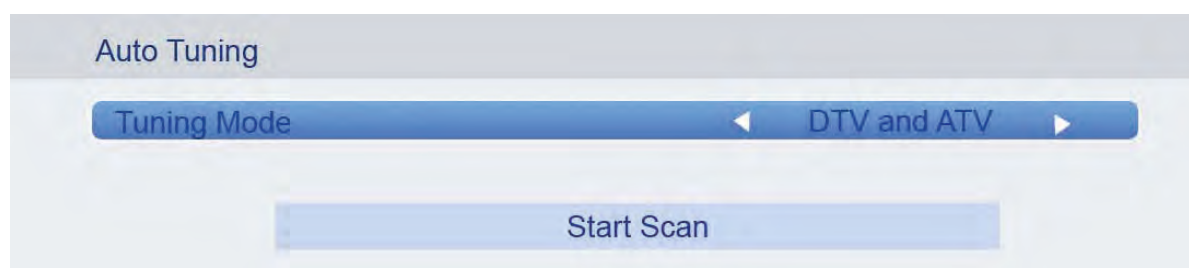

Select to open the auto search page, and press Enter button to start the scan.

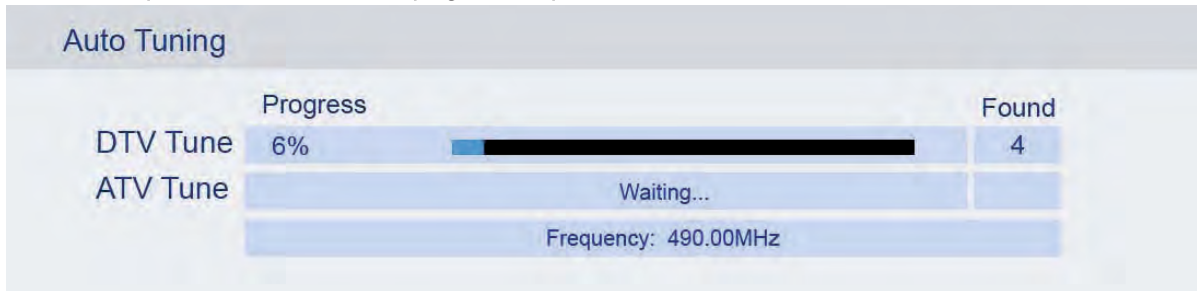

#### 4.3.6 ATV Manual Tuning

Press ▲/▼ button to select **ATV Manual Tuning**, and then press **ENTER** button to start the scan.



#### 4.3.7 DTV Manual Tuning

Press ▲/▼ button to select **DTV Manual Tuning**, and then press **ENTER** button to start the scan.





By pressing the number keys and the direction keys, user can set the channel, date, start time, repeat, operation and record length information in this menu.

When approaching the preset time, the screen will show a countdown to remind the user.

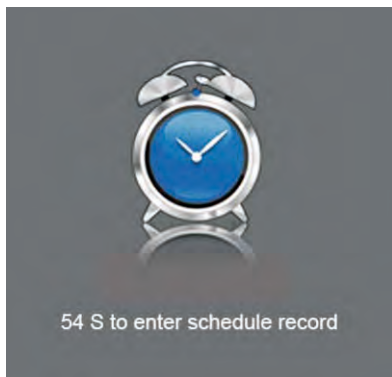

#### 4.3.11 Guide

Press **▲/▼** button to select **Guide**, and then press **ENTER** button to display the EPG programs list, as follows:

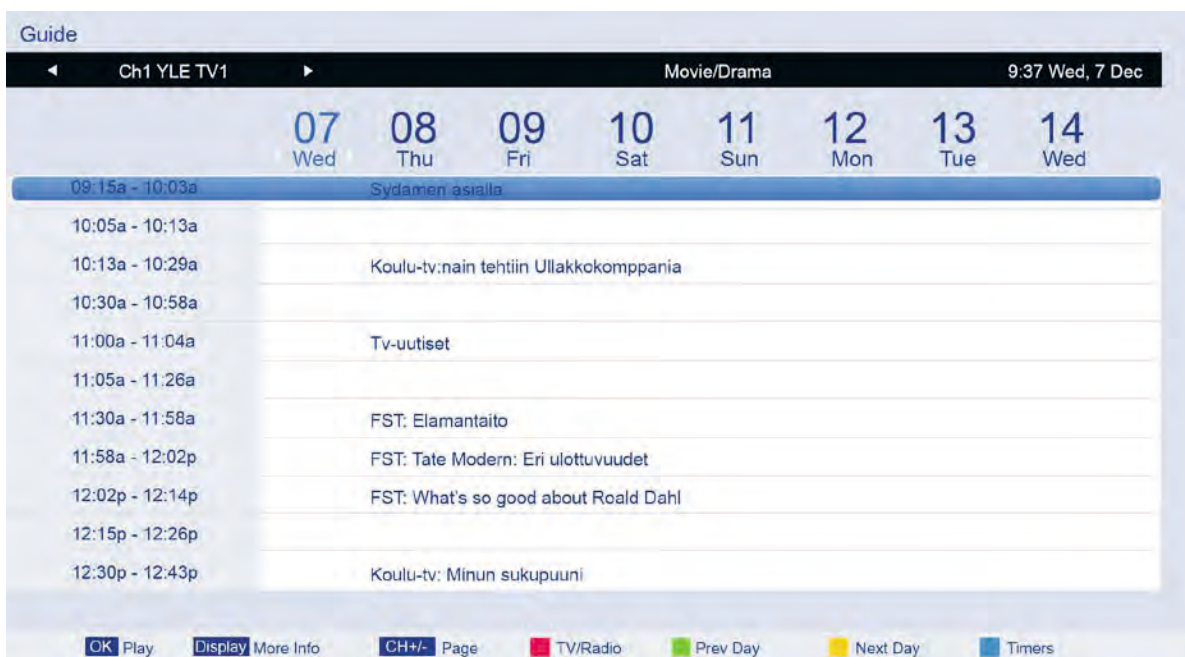

User can also press the **EPG** Button on the remote control to display the EPG programs list.

## 4.4 PREFERENCES

The picture is for a reference only; the actual items are the ones appearing in your TV.

Press **MENU** button to display the main menu.

Press **▲/▼** button to select **PREFERENCES** in the main menu, and then press **ENTER** or **▶** to enter.

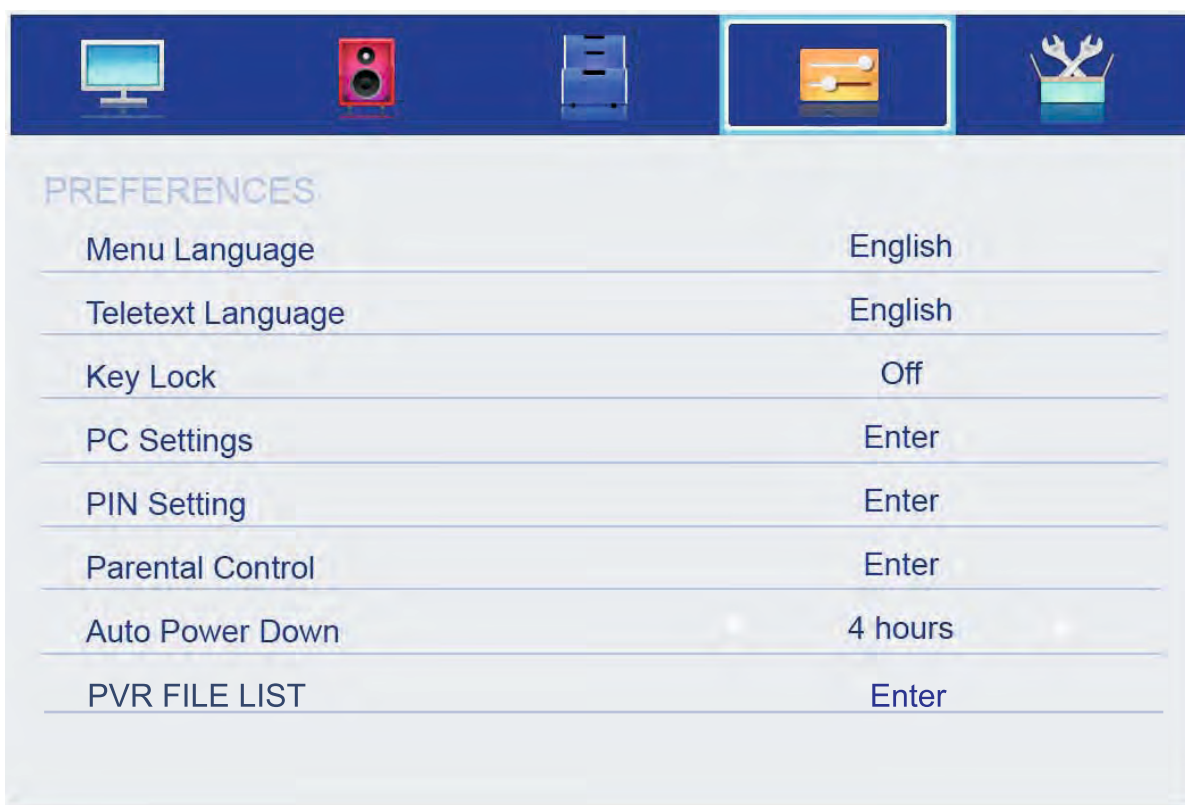

1. Press **▲/▼** button to select the option that you want to adjust in the **PREFERENCES** menu, then press **ENTER** to enter.
2. Press **◀/▶** button to adjust or press **▲/▼** button to select.
3. After finishing your adjustment, press **MENU** button to save and return back to the previous menu and press **EXIT** button to exit from the menu.

### 4.4.1 Menu Language

Press **▲/▼** button to select **Menu Language**, then press **ENTER** or **▶** button to enter the submenu, then press **▲/▼** button to select, then press **ENTER** or **▶** button to confirm.

### 4.4.2 Teletext Language

Press **▲/▼** button to select **Teletext Language**, then press **ENTER** or **▶** button to enter the submenu, then press **▲/▼** button to select, then press **ENTER** or **▶** button to confirm.

### 4.4.3 Key Lock

Press **▲/▼** button to select **Key Lock**, then press **ENTER** button to enter and press **◀/▶** button to select ON or OFF.

#### 4.4.4 PC Settings

Press ▲/▼ button to select **PC Settings**, then press **ENTER** to enter the submenu, Then press ► to enter, then press **ENTER** or ► to confirm (when a PC signal is connected).

#### 4.4.5 PIN Setting

Press ▲/▼ button to select **PIN Setting**, then press **ENTER** button to enter the submenu by using the password “0000”:

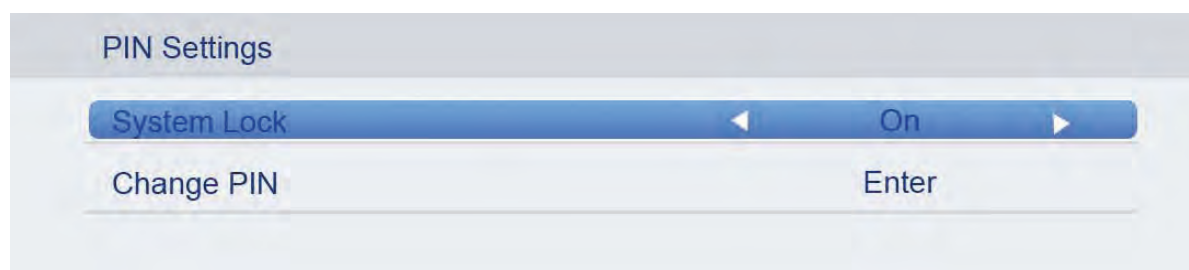

##### 4.4.5.1 System Lock

Press ▲/▼ button to select **System Lock**, then press ◀/▶ button to select ON or OFF.

##### 4.4.5.2 Change Pin

Press ▲/▼ button to select **Change Pin Code**, then press **ENTER** to enter and the Change Pin Code menu will appear as follows:

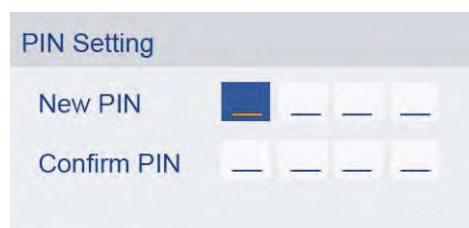

Enter the old password at “Old Password” (if the old password is incorrect, the password will not be allowed to be modified.)

Enter the new password at “New Password”.

Enter the new password again at “Confirm New Password”. If the new password and the confirmation of new password match, the successfully updated menu will appear in a few seconds, otherwise, the menu will display the passwords mismatch.

#### 4.4.6 Parental Control

Press ▲/▼ button to select **Parental Control**, then press **ENTER** or ► button to enter the submenu. Then press ▲/▼ button to select Rate (From 4-17, or None). Then press **ENTER** or ► button to confirm.

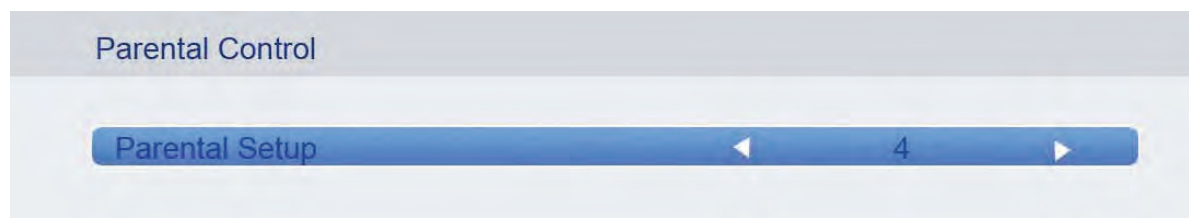

#### 4.4.7 Auto Power Down

Press ▲/▼ button to select **Auto Power Down** and press ◀/▶ button to select Off/ 1 hour/ 2 hour/ 4 hour.

#### 4.4.8 Hotel Mode

Press ▲/▼ button to select **Hotel Mode** and press **ENTER** or ▶ button to enter **Hotel Mode** setting

### 4.5 SETUP

The picture is for a reference only; the actual items are the ones appearing in your TV.

Press **MENU** button to display the main menu.

Press ▲/▼ button to select **Setup** in the main menu, then press **ENTER** to enter.

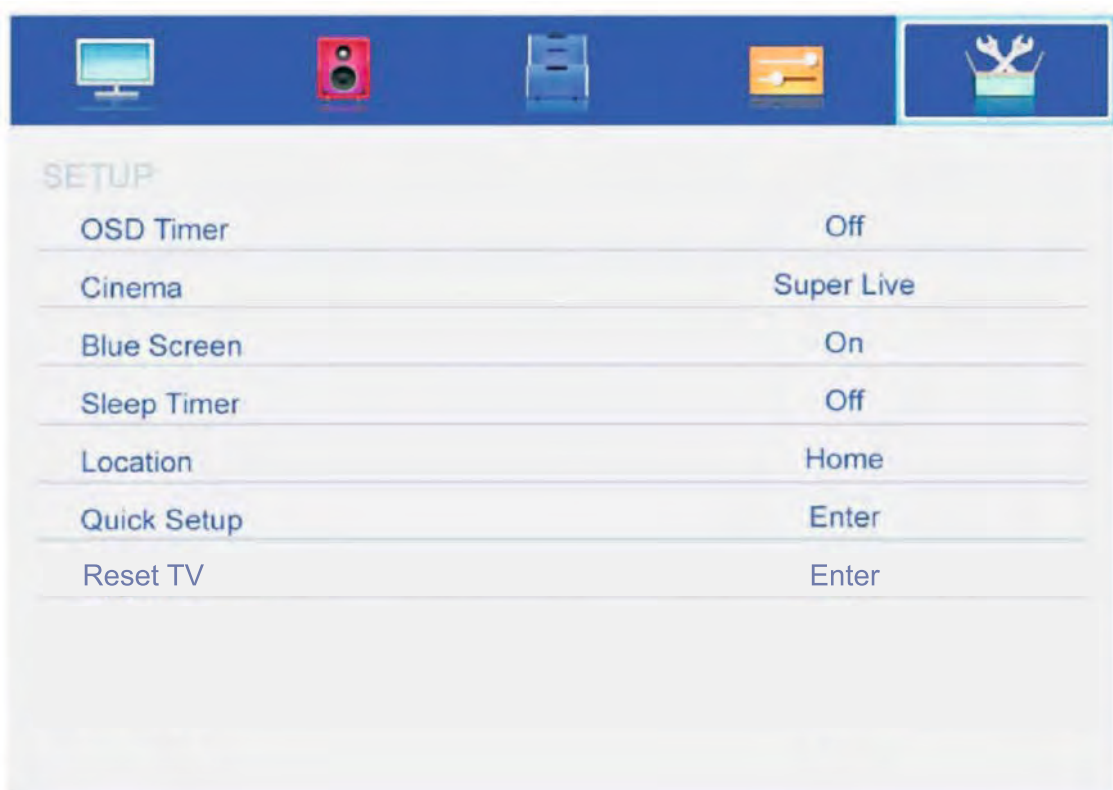

1. Press ▲/▼ button to select the option that you want to adjust in the **Setup** menu, then press **ENTER** or ▶ button to enter.
2. Press ◀/▶ button to adjust or press ▲/▼ button to select.
3. After finishing your adjustment, press **MENU** button to save and return back to the previous menu and press **EXIT** button to exit from the menu.

#### 4.5.1 OSD Timer

Press ▲/▼ button to select **OSD Timer**, and then press ◀/▶ button to select. (Available OSD Timer modes: 10 S, 20 S, 30S, 40S, 50S, 60S, off), then press **ENTER** button to confirm.

#### 4.5.2 Cinema

Press ▲/▼ button to select **Cinema**, and then Press ◀/▶ button to select. (Available Cinema modes: Auto, 4x3, Wide, Super Live), then press **ENTER** button to confirm.

#### 4.5.3 Blue Screen

Press ▲/▼ button to select **Blue Screen**, then press ◀/▶ to select On or Off. Then press **ENTER** to confirm.

#### 4.5.4 Sleep Timer

Press ▲/▼ button to select **Sleep Timer**, and then press ◀/▶ button to select. (Available Sleep Timer modes: 00:15, 00:30, 01:00, 01:30, 02:00, off), then press **ENTER** button to confirm.

#### 4.5.5 Location

Press ▲/▼ button to select **Location**, and then press ◀/▶ button to select Home or Store, then press **ENTER** button to confirm.

#### 4.5.6 Quick Setup

Press ▲/▼ button to select **Quick Setup**, and then Press then press **ENTER** button to enter the submenu, enter the password if locked, and then you can quickly make some basic settings of the TV, as follows:

##### 4.5.6.1 Language

User can press ◀/▶ button to select the language of television programs.

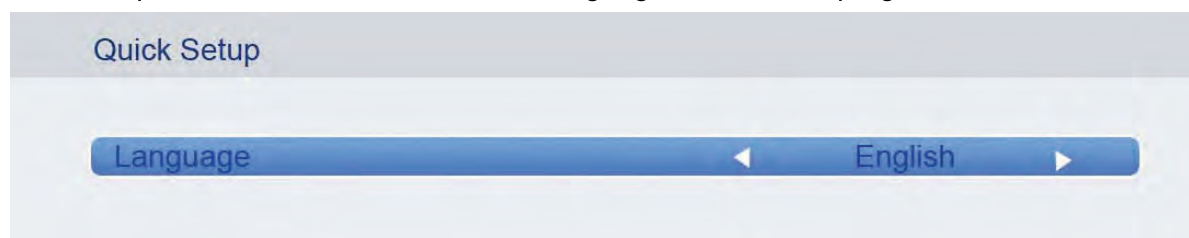

Then press **ENTER** to enter the next step page.

##### 4.5.6.2 Country

User can press ◀/▶ button to select the country.



Then press **ENTER** to enter the next step page.

##### 4.5.6.3 DTV Type

User can press ◀/▶ button to select the DTV Type: Cable or Terrestrial.



Then press ENTER to enter the next step page.

#### 4.5.6.4 Subtitle and Audio Language settings

Press ▲/▼ button to select the item, and then press ◀/▶ button to select the options.



User can set the primary and secondary subtitle language, primary and secondary audio language by these options.

Then press ENTER to enter the next step page.

#### 4.5.6.5 Auto Tuning



Press ▲/▼ button to select the item, and then press ◀/▶ button to select the options.

##### **Tuning Mode**

User can press ◀/▶ button to select the Tuning Mode: DTV/ ATV/ DTV and ATV.

##### **Scan Type**

User can press ◀/▶ button to select the Scan Type: Full Scan/ Network Search.

##### **Network ID**

This option is only available if the network search is activated.

User can press the number keys to set the Network ID, or automatically search for ID address.

##### **Frequency**

This option is only available if the network search is activated.

User can press the number keys to set the frequency, or automatically search the frequencies.

#### **Modulation**

User can press ◀/▶ button to select the Modulation: 16QAM/ 32QAM/ 64QAM/ 128QAM/ 256QAM.

#### **Symbol Rate**

User can press the number keys to set the symbol rate, or automatically search for a symbol rate.

After completing the above settings, user can start channel search.

#### **4.5.7 Reset TV**

Press ▲/▼ button to select **Reset TV**, and then press **ENTER** to enter the sub menu, enter the password if locked, and then you can restore factory settings.

#### **4.5.8 Shopping mode**

Press ▲/▼ button to select **Shopping mode**.

## **4.6 HOTEL MODE SETTINGS**



Hotel Mode Settings	
Hotel Mode	On
Panel Lock	Off
Setup Menu Lock	Off
Max Volume	100
Default Volume	Off
Volume	30
Picture Mode	Standard
Power on Source	Disabled

### **1. How to enter and exit the hotel mode menu:**

- ◆ Enter : You can enter the hotel mode menu by the follow steps :  
Enter the password "4588" under the source menu.
- ◆ Select : Use the direction keys to select the different items.
- ◆ Confirm : Press the key "ENTER" or the right direction key to confirm.

## 2. Function description of hotel mode :

Function Name	Value	Default	Note
<b>Hotel Mode</b>	(OFF/ON)	OFF	If set to "On", the next functions in the list will be activate or adjustable, it will open the hotel mode.
<b>Panel Lock</b>	(OFF/ON)	OFF	If set to "On", the keypad is locked, then the user cannot use any button on the keypad. If set to "Off", all keypad items are effective. The default is Off.
<b>Setup Menu Lock</b>	(OFF/ON)	OFF	If set it to "On", the button of main menu is locked, and the OSD of main menu cannot be used. If set to "Off", the Main Menu item is effective. The default is Off.
<b>Max Volume</b>	(0 ~ 100)	100	To set the max volume value, and select one value of 0 to 100, when you adjust the volume, the volume value cannot exceed the maximum volume setting. The default value is 100.
<b>Default Volume</b>	(OFF/ON)	OFF	To enable/disable the default volume. If set to "On", you can set the default volume value by the follow item. If set to "Off", you cannot set the default volume value.
<b>Volume</b>	(0 ~ 100)	30	To set the default volume value when the default volume is "ON". The TV will auto set the default volume value when TV power is on.
<b>Picture Mode</b>	OFF Standard Movie Mild User Dynamic	OFF	To set the default picture mode. When you set this item to "OFF", it will save the user setting.
<b>Power on Source</b>	Disable/ All Sources	Disable	To set the default source when the TV power is on. If the item is set to "Disable", it will default to the user setting.
<b>Power on Standby</b>	(Disable/Enable)	Disable	To set the power on mode. If the item is set to "Disable", the TV will auto power on when plugged to AC. If it is set to "Enable", the TV will automatically enter standby mode. You can

			power or use the RC. The default value is "Disable".
<b>Channel Scan Lock</b>	(OFF/ON)	OFF	If the item is set to "On", then the user can't scan or search the TV. If set to "Off", Channel Scan item is effective. The default is Off.
<b>Aspect Ratio Lock</b>	(OFF/ON)	OFF	If set to "On", the "ASPECT" can not be adjusted and it is locked.
<b>Source Lock</b>	(OFF/ON)	OFF	To use this setting, the user must firstly set the hotel mode to "on", otherwise this item cannot be adjusted. If this item is set to "on", the next source lock will be activated. The default value is off.
<b>Press [Enter] to Clear Hotel Mode Set</b>	N/A	N/A	Select the item and press the ENTER button on the RC, It will reset the hotel mode settings to the default value.

## 4.7 How to user Record

The HK-RTD2957 supports two types of recording:

- A、 Direct Record
- B、 Subscribe Record

### Direct Record.

1. In the DTV source, you can start the recording function by pressing the "REC" key while a program is playing. Before that, you have to make sure that the USB storage device is inserted and the device checking and Initialization has been done.

If you press "REC" key when there's no USB storage device inserted, a prompt window will appear, as follows.

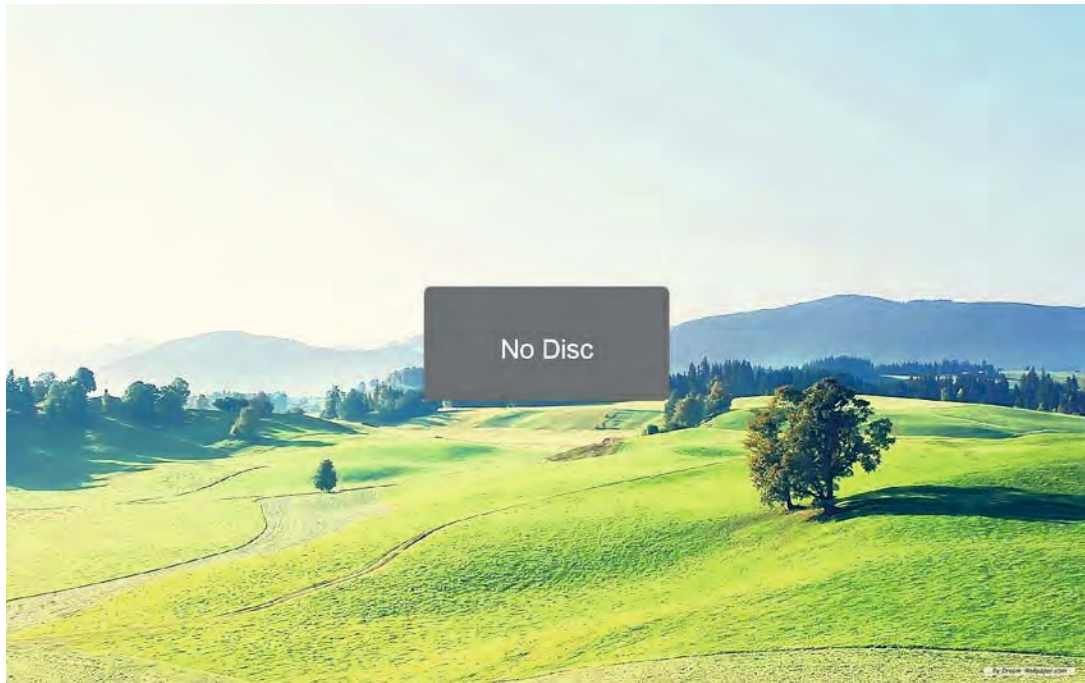

If you press “REC” key during the device checking and Initialization, the prompt window will show a black screen for about 2s. When the TV is recording, the recording menu will appear.

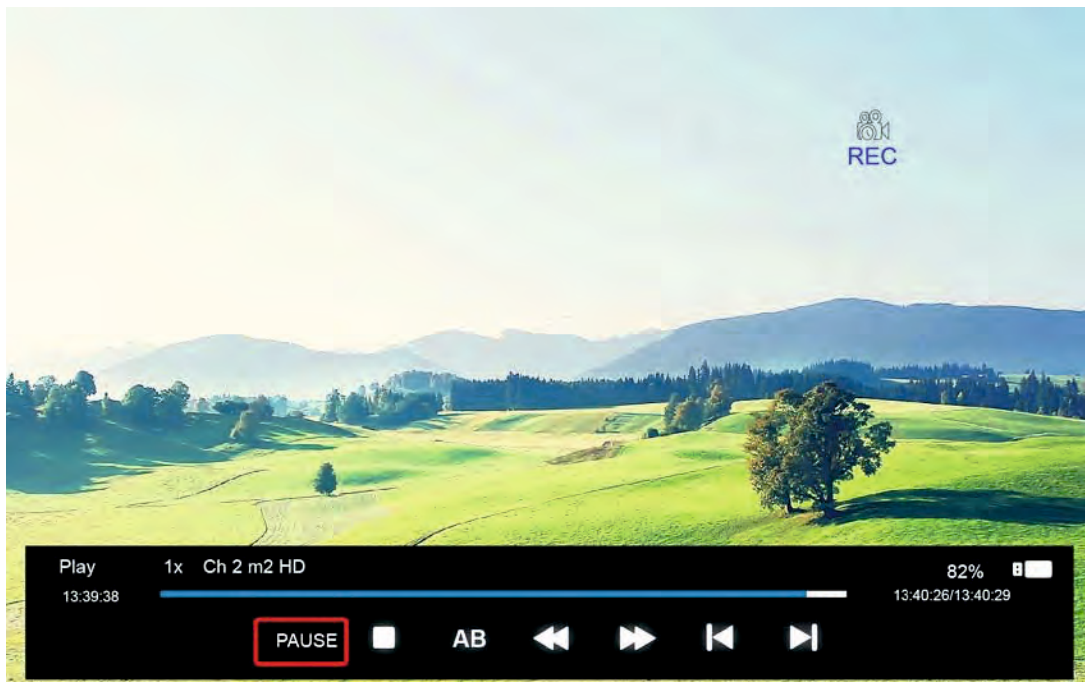

2. After the recording has started, you can select the the functions: PLAY/PAUSE/STOP/AB/FF/FR/PRVE/NEXT。 You can seen the detailed info in the recording menu.

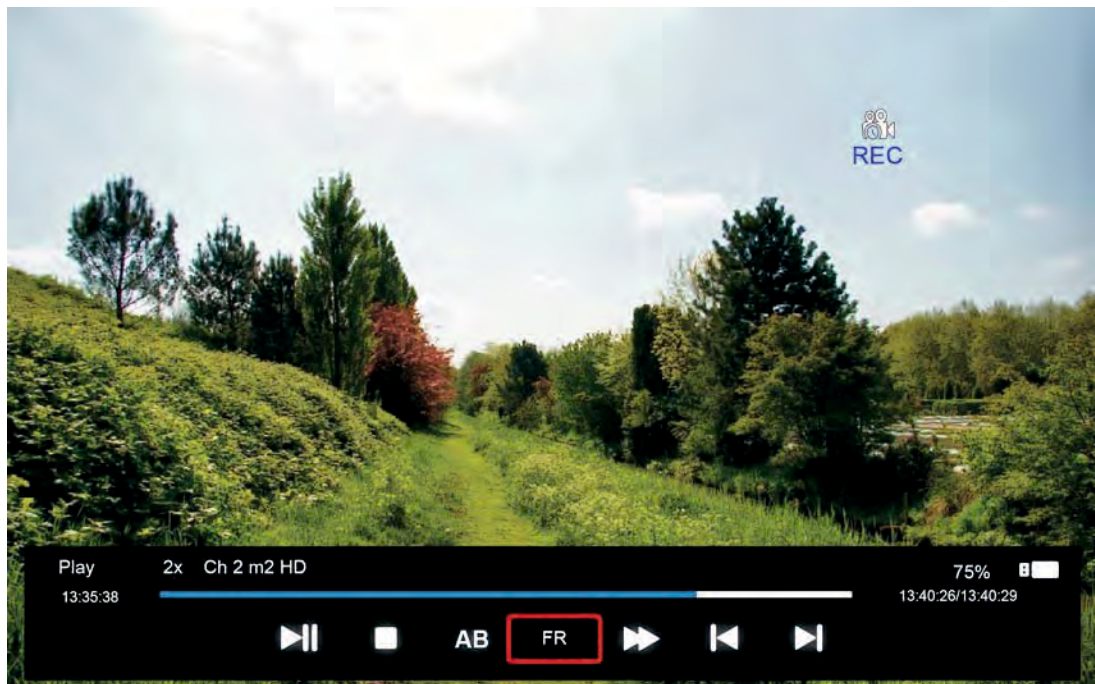

PLAY/PAUSE: you can set the play mode PLAY/PAUSE;

STOP: you can stop the recording, a menu will appear for checking whether to stop the recording.

AB: you can set two points for playing the record file, from A to B.

FF/FR: you can set the play mode FF/FR;

PRVE/NEXT: you can play the record file to PRVE/NEXT 30s.

3. After recording has started, you can press the button PLAY/FF/FR/PRVE/NEXT on the RC. You can play the record file by PALY/PAUSE/FF/FR/PRVE/NEXT/STOP.

4. You can press "STOP" key to stop recording function after your confirmation.

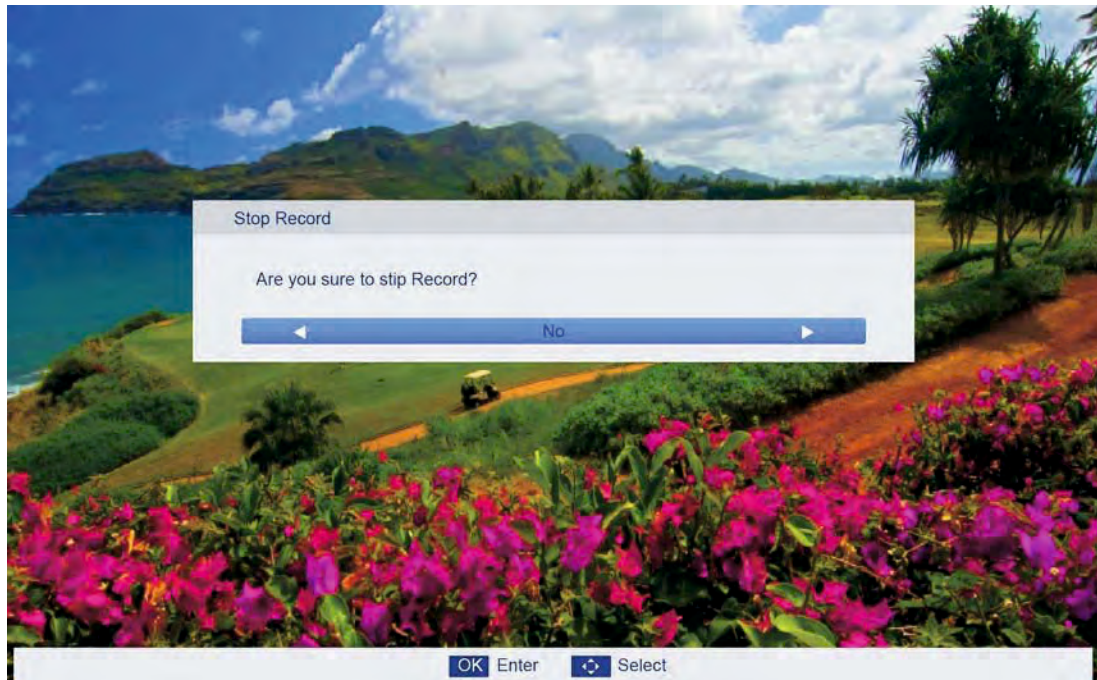

## Subscribe Record

1. In the DTV source, you can enter the Timer menu and set the Subscribe Record. Press the "ENTER" key to add the recording task.

The steps: Main menu--->APPLICATIONS--->Programme Timers---> Programme Timers

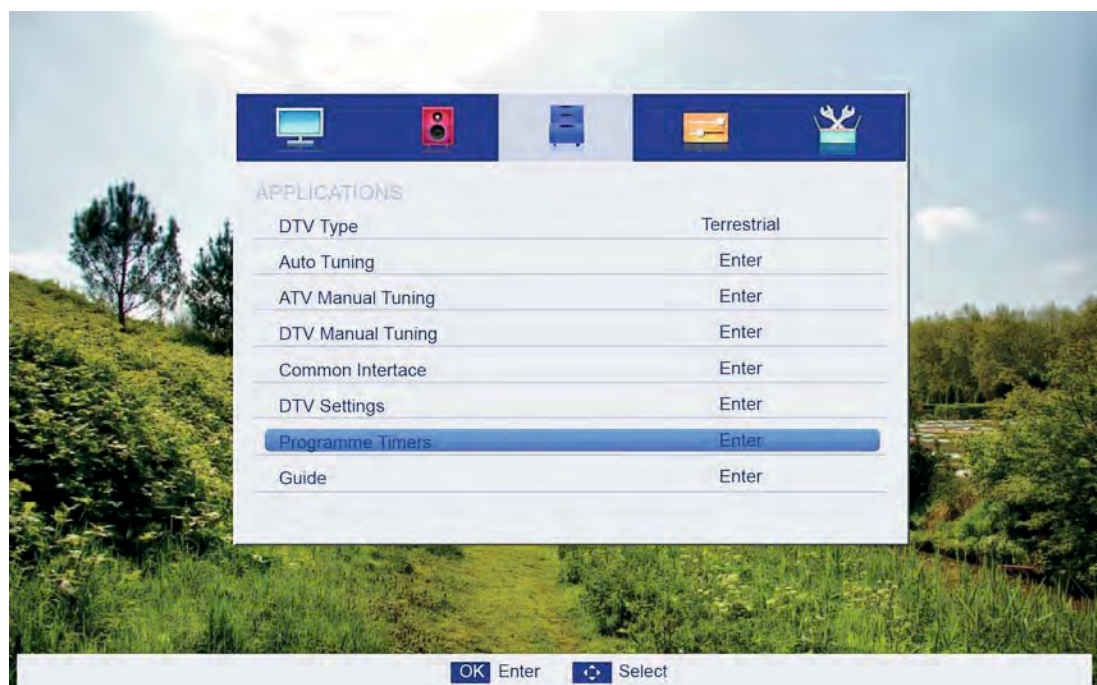



2. If you enter the Timer Edit menu, you can set the recording task that you want to record.

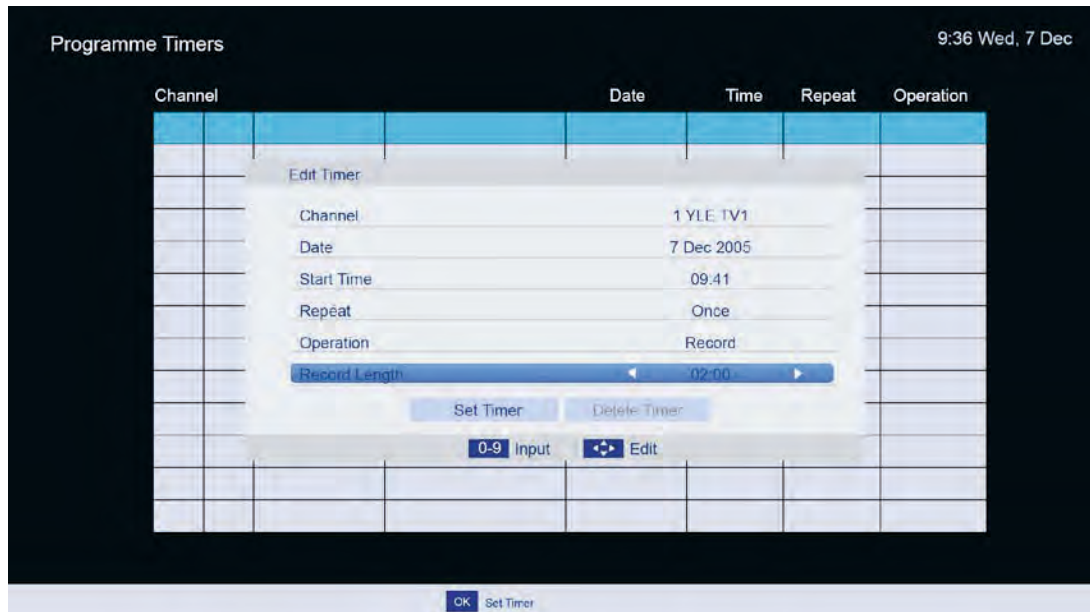

3. When you set the recording task successfully, if the TV is standby mode, it will auto power on three minutes before starting of the task.
4. When the recording task time has started, it will automatically record, but you must check if your USB storage device is inserted and has enough speed to record. Otherwise the task will fail.
5. The TV enters false standby mode when the task is started. You can press the "POWER" key to watch the TV program. You can do the same operation as in Direct Record. When you press "POWER" again, if the task is not over, the TV will power off the panel and continue to record. The TV will actually power off when the recording task is over.
6. When you open the EPG menu, press the BLUE button. You can also enter the programming time menu.



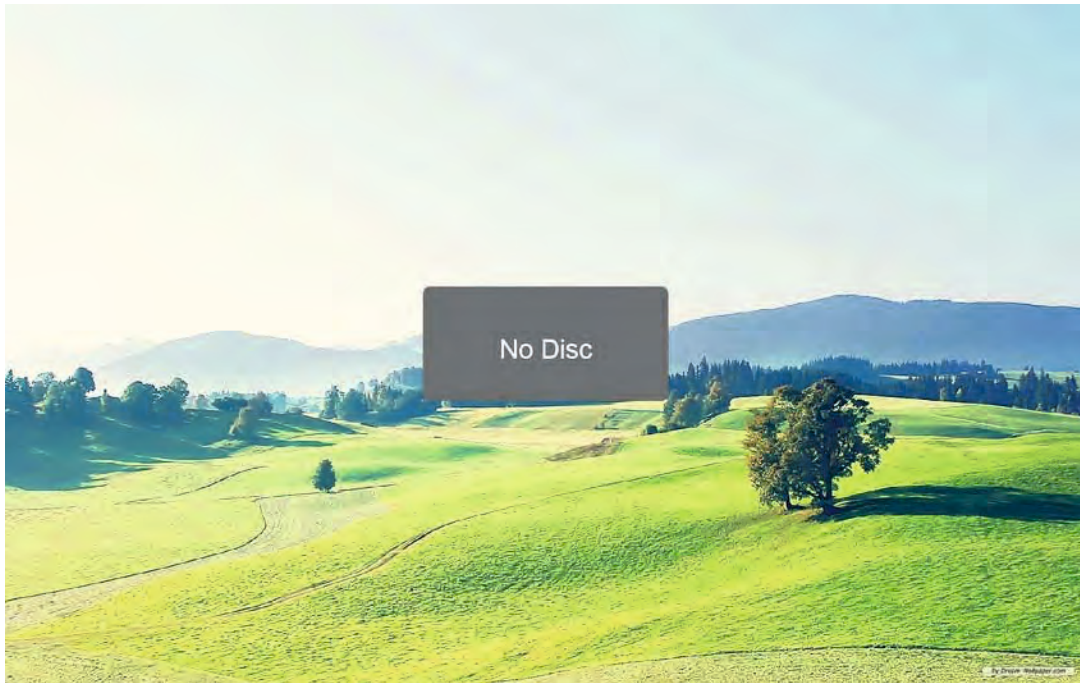

If you press the “PLAY/PAUSE” key during the device checking and initialization, a prompt window will appear, as follows.

If you press the “PLAY/PAUSE” key during the device checking and initialization, the prompt window will show a black screen for about 2s. When the TV is timeshifting, it will show the timeshift menu.

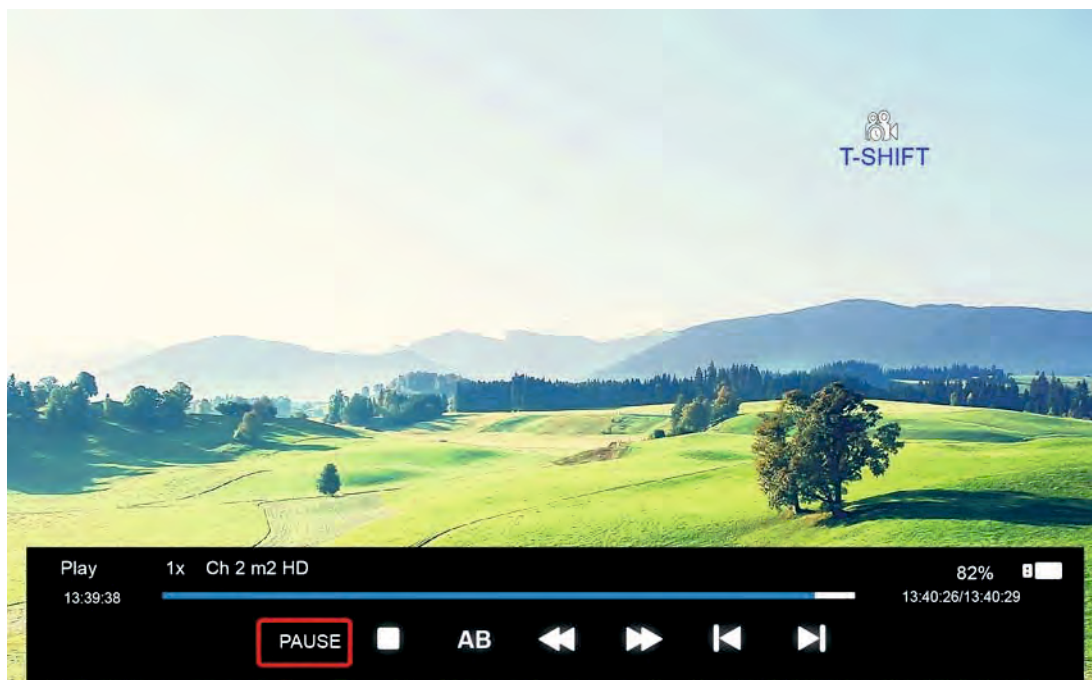

2. After time shift has started, you can select the items for the functions: PLAY/PAUSE/STOP/AB/FF/FR/PRVE/NEXT. You can see the detailed info in the time shift menu.

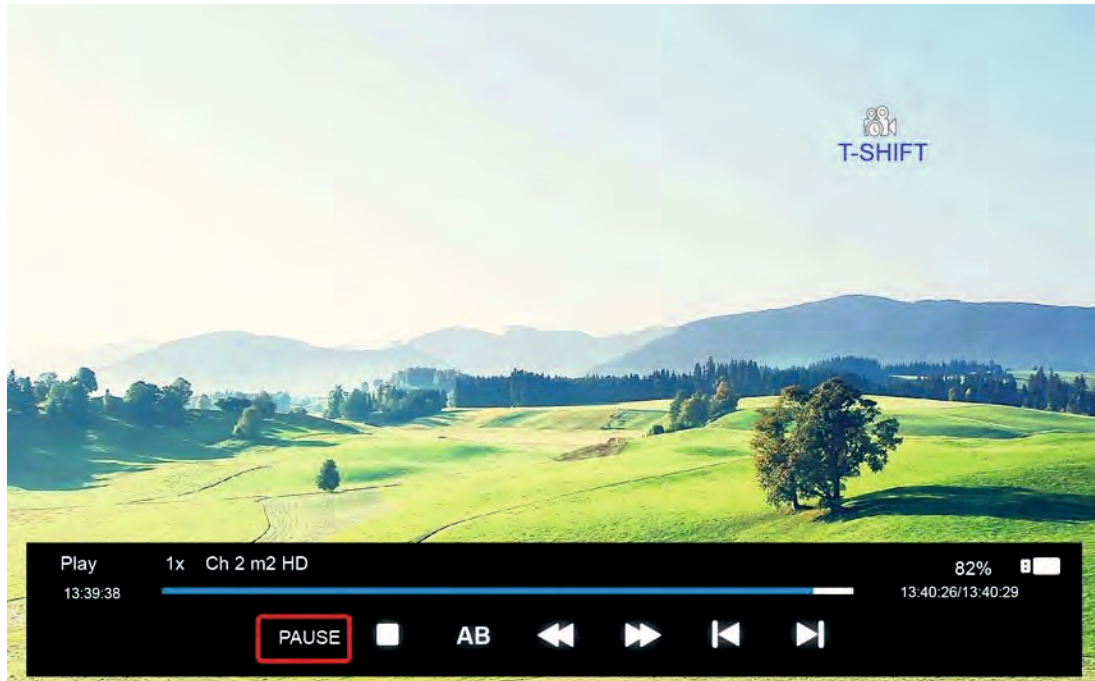

PLAY/PAUSE: you can set the play mode to PLAY/PAUSE;

STOP: you can stop the recording, the menu for checking whether to stop the recording will appear.

AB: you can set two points for play the recording file from A to B.

FF/FR: you can set the play mode to FF/FR;

PRVE/NEXT: you can play the record file to PRVE/NEXT 30s.

3. After recording has started, you can press the button PLAY/FF/FR/PRVE/NEXT on the RC and you can play the recording file by PALY/PAUSE/FF/FR/PRVE/NEXT/STOP.

4. You can press "STOP" key to jump to the real time broadcasting of the program, and with another press of "STOP" key, you can stop time shift function after your confirmation.

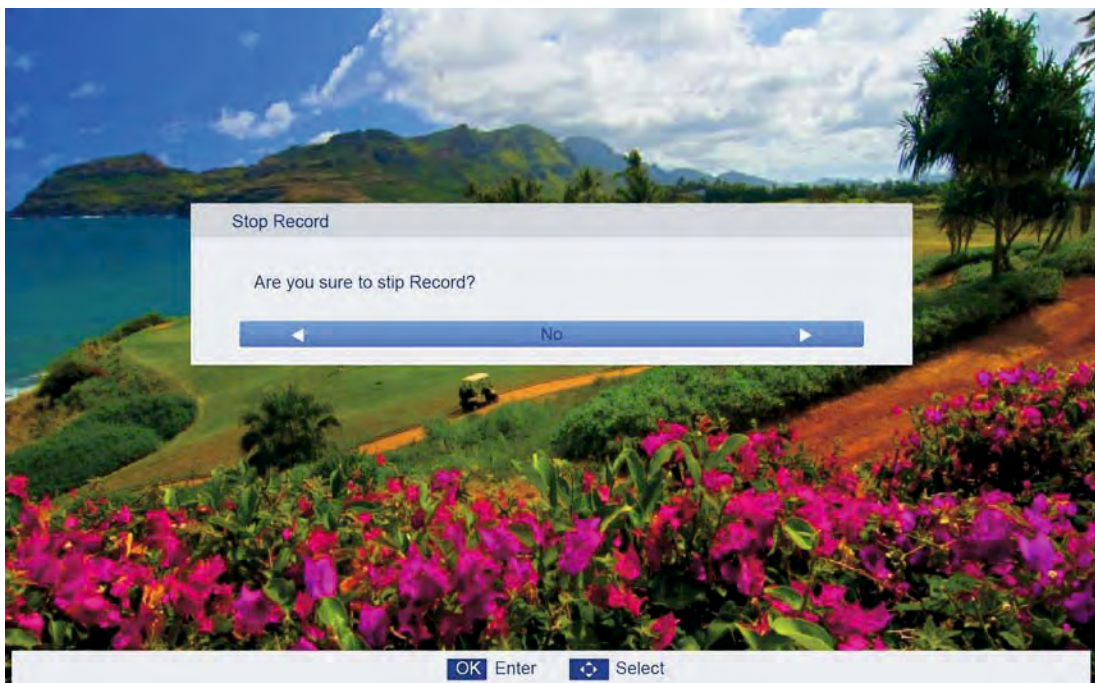

Note: Time shift function will stop when there's no space left on the USB storage device.  
Press the ● button on the remote to record a TV program, as follows:

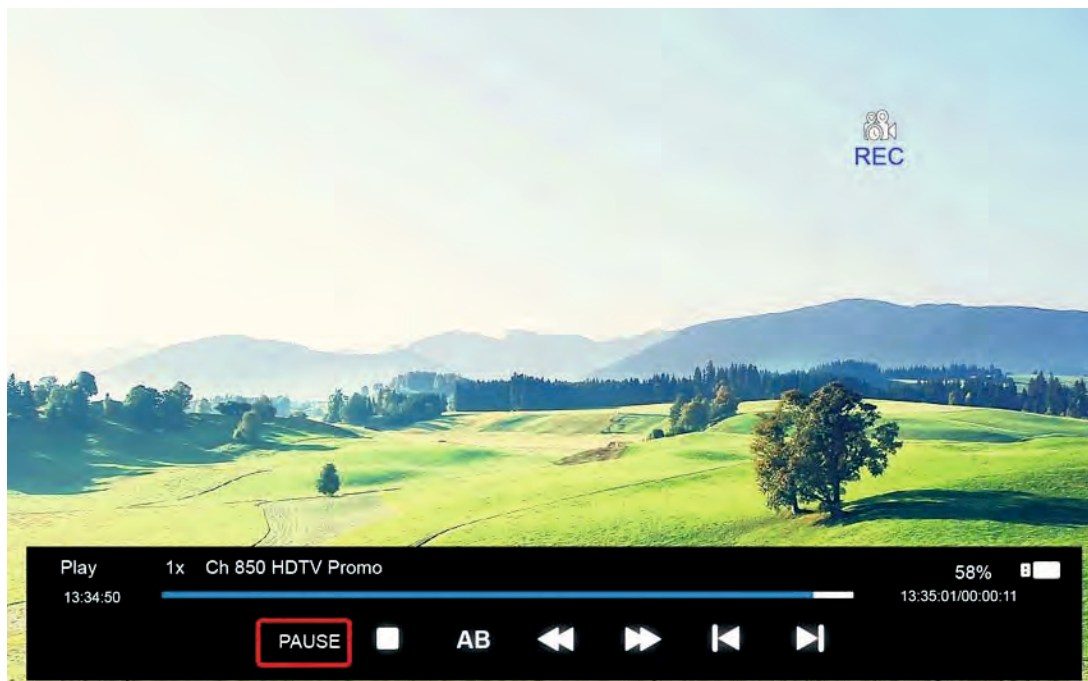

User can change the playback mode through the various buttons above when recording is on.

### **PVR FILE LIST**

After the recording is complete you can press **REC.FILE** button on the remote to display the PVR FILE LIST.

Press ▲/▼ to select **record program file (.ts file)**.

Press **ENTER** to play.

Press red button to delete the selected file.



If you press **ENTER** to play, a menu will appear as follows:



- Notes:** 1.This is just an example for reference, different CI modules will have different CI menus.  
2. Other menus and descriptions are the same as those for TV source.

## 5. MEDIA OPERATION

The picture is for a reference only; the actual items are the ones appearing in your TV.

Note: Before using the **MEDIA** menu, plug in a USB device or memory card, then press **SOURCE** button to set the Source to Media.

Press **▲/▼** button to select **MEDIA** in the **Source Menu**, and then press **ENTER** or **▶** to enter. You can also enter the Media by pressing **MEDIA** button on the remote control.

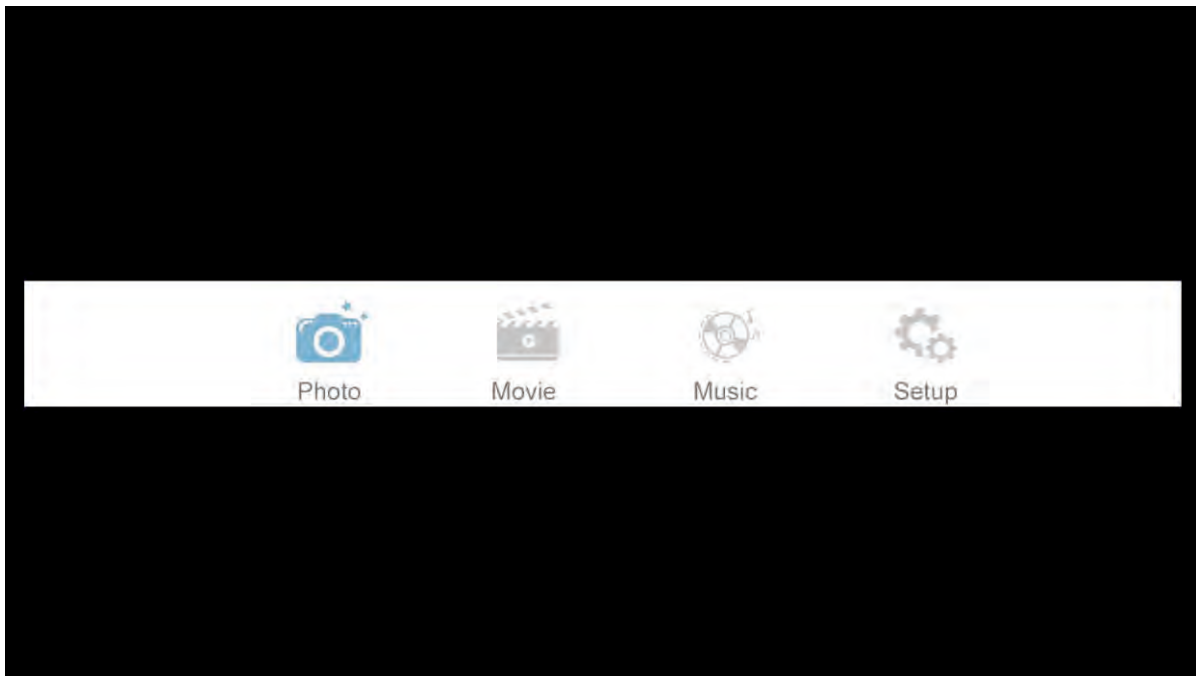

1. Press **▲/▼** button to select the option that you want to adjust in the **Media** menu, then press **ENTER** or **▶** button to enter.
2. Press **◀/▶** button to adjust or press **▲/▼** button to select.
3. After finishing your adjustment, press **MENU** button to save and return back to the previous menu and press **EXIT** button to exit from the menu.

## 5.1 Photo

The picture is for a reference only; the actual items are the ones appearing in your TV.  
Press ◀/▶ button to select **Music** in the main menu, and then press **ENTER** button to enter.  
Press **EXIT** button to return back to the previous menu.

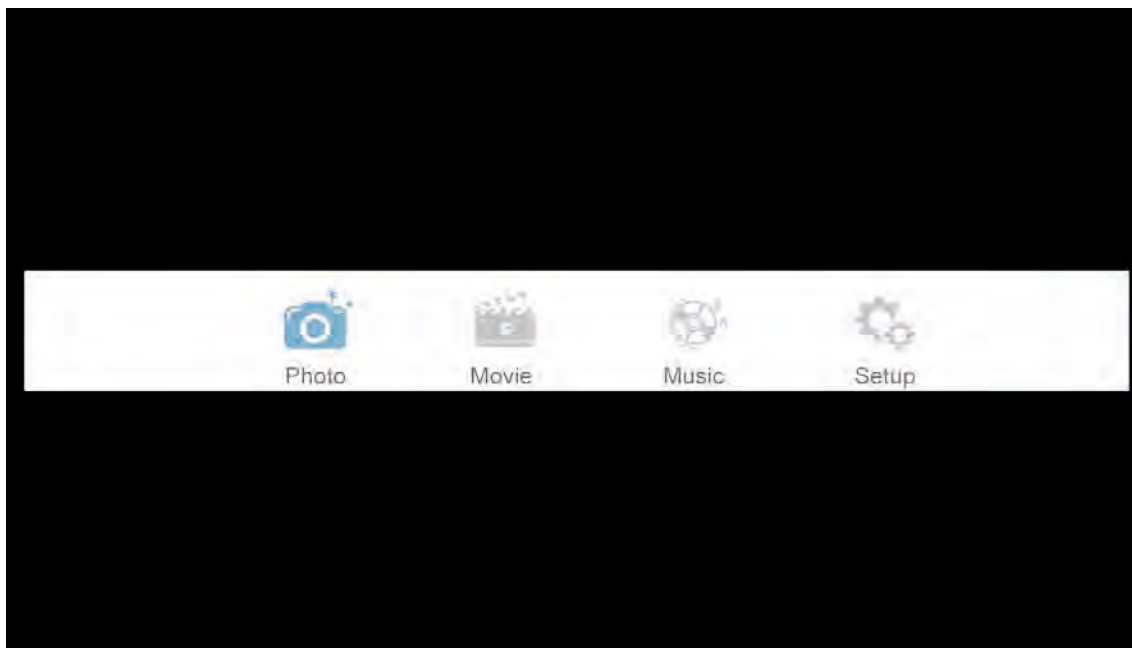

Press ▲/▼ to select the photos, press **ENTER** or ▶ || button to view.

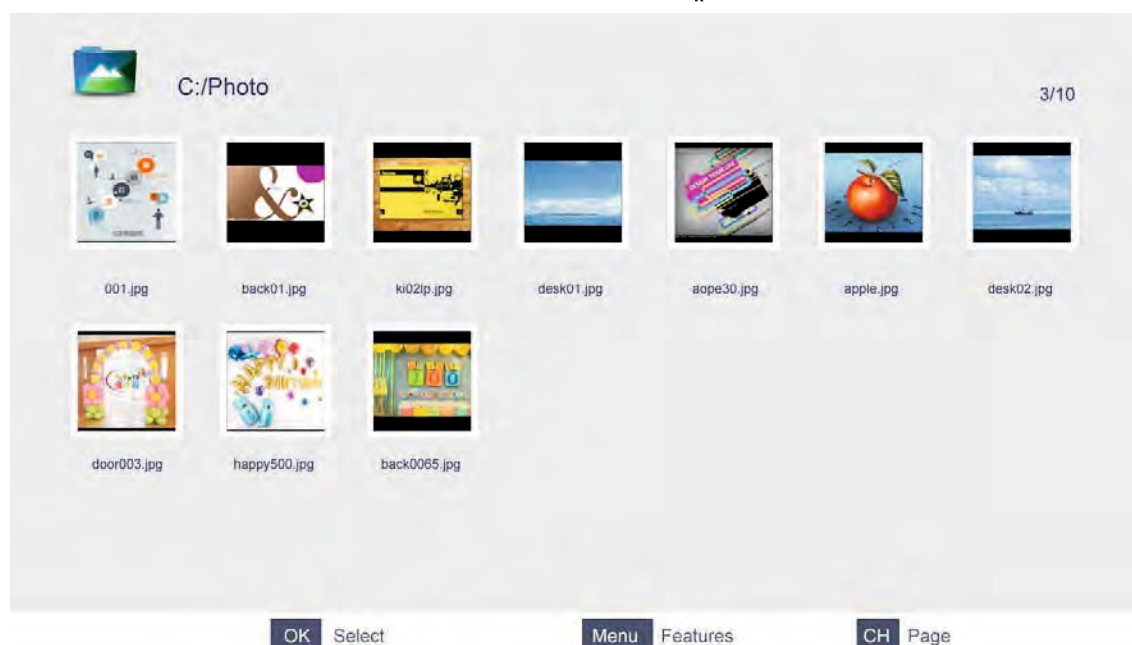

You can see the information of the current playing photo after pressing **INFO** button, then press ▶ || button to play or pause, you can see the playing state on the right.  
Then press ▲/▼ or ◀/▶ button to rotate the picture.

**Notes:** Other menus and descriptions are the same as those for Movie menu.

## 5.2 Movie

The picture is for a reference only; the actual items are the ones appearing in your TV.  
Press ◀/▶ button to select **Movie** in the main menu, then press **ENTER** button to enter.  
Press **EXIT** button to return to the previous menu.

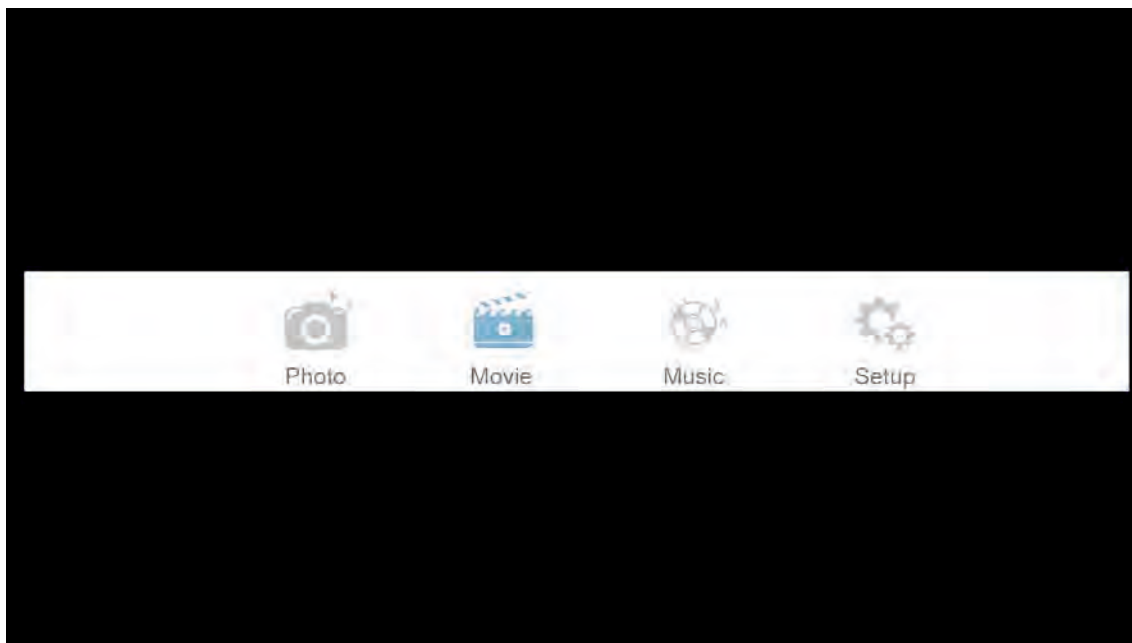

Press ▲/▼ button to select the folder that you want to view.  
Press **ENTER** button to select the subfolder.

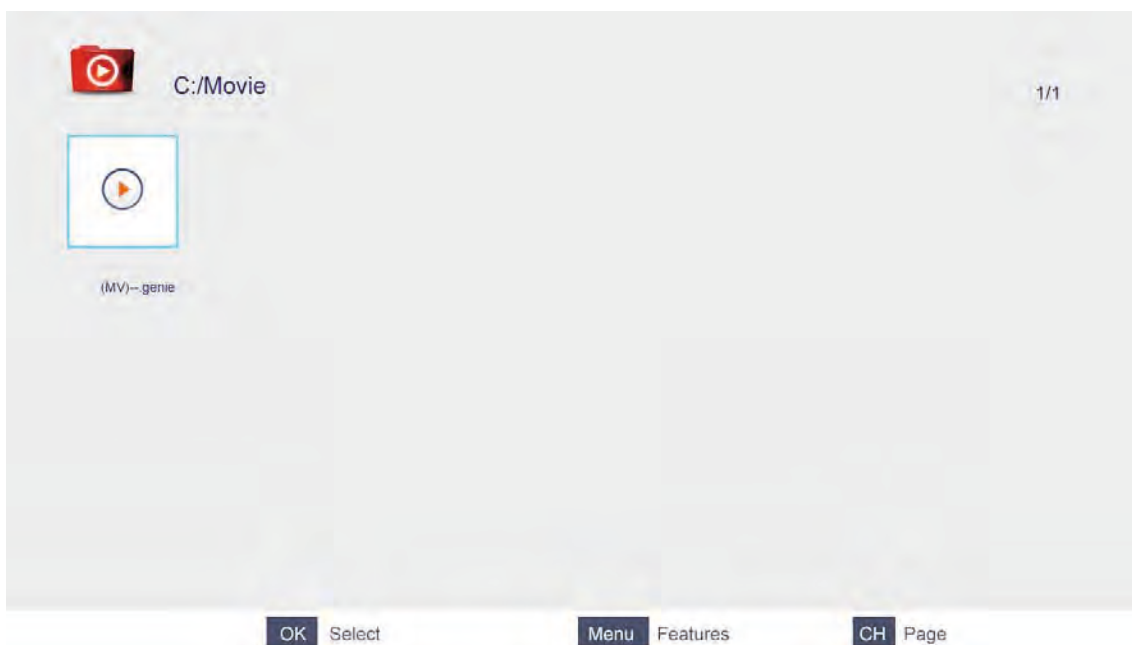

Press **ENTER** button or ▶ || button to play.  
Press ■ button or **EXIT** button to stop playing.  
Press the ◀ button to return to previous page.  
You can see the information of the current playing media within the first few seconds or after pressing **INFO** button.

## 5.3 Music

The picture is for a reference only; the actual items are the ones appearing in your TV.  
Press ◀▶ button to select **Music** in the main menu, and then press **ENTER** button to enter.  
Press **EXIT** button to return to the previous menu.

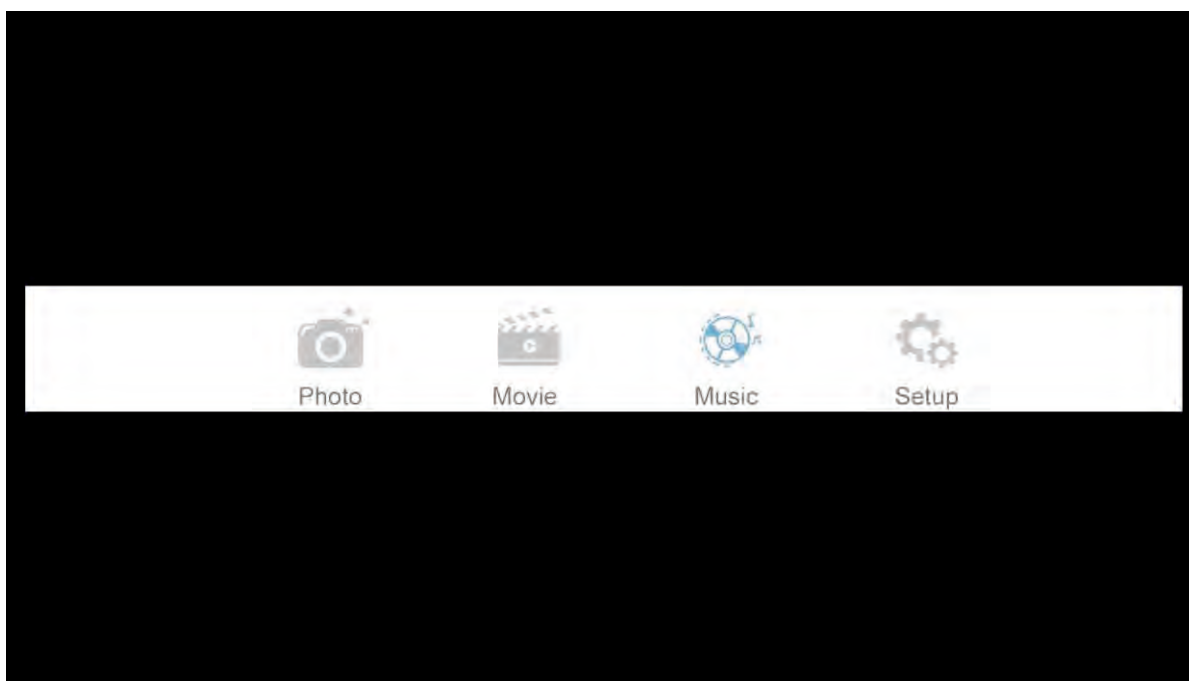

Press ▲/▼ button to select the song you want to listen to, and then press **ENTER** or ▶ || or ▶ button to play.

Press ◀ button to return to the previous menu.

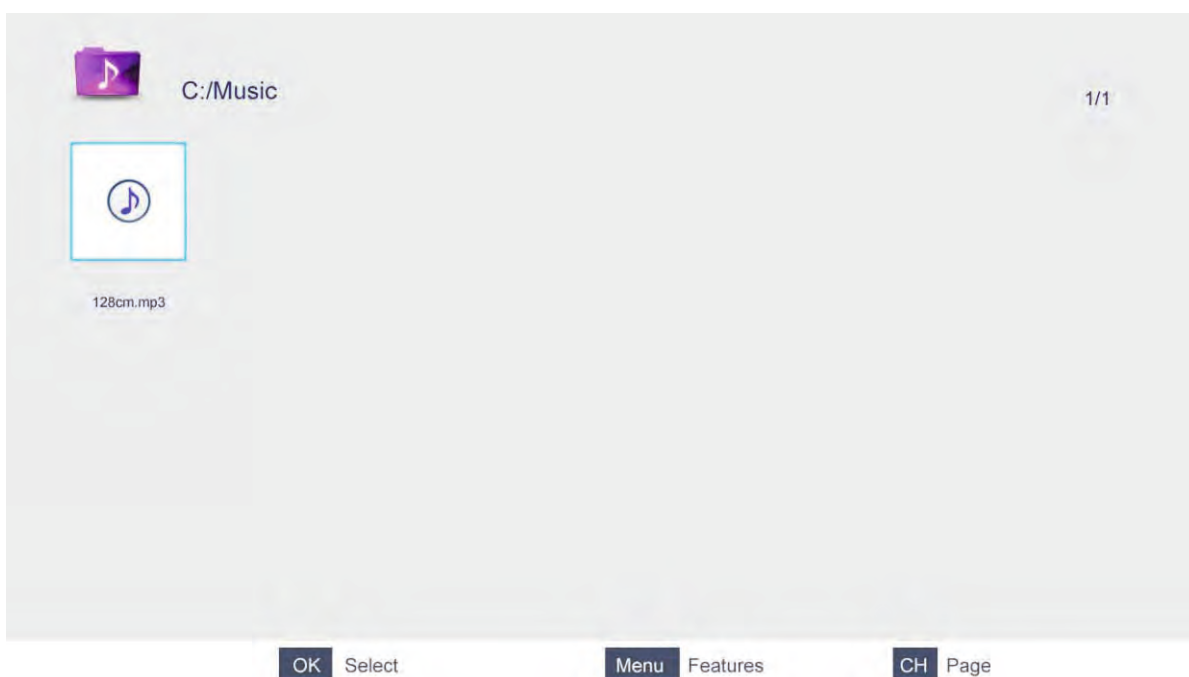

You can see the information of the current playing song on the left of the menu.

## 5.4 Setup

The picture is for a reference only; the actual items are the ones appearing in your TV.  
Press ◀/▶ button to select **Setup** in the main menu, and then press **ENTER** button to enter.  
Press **EXIT** button to return to the previous menu.

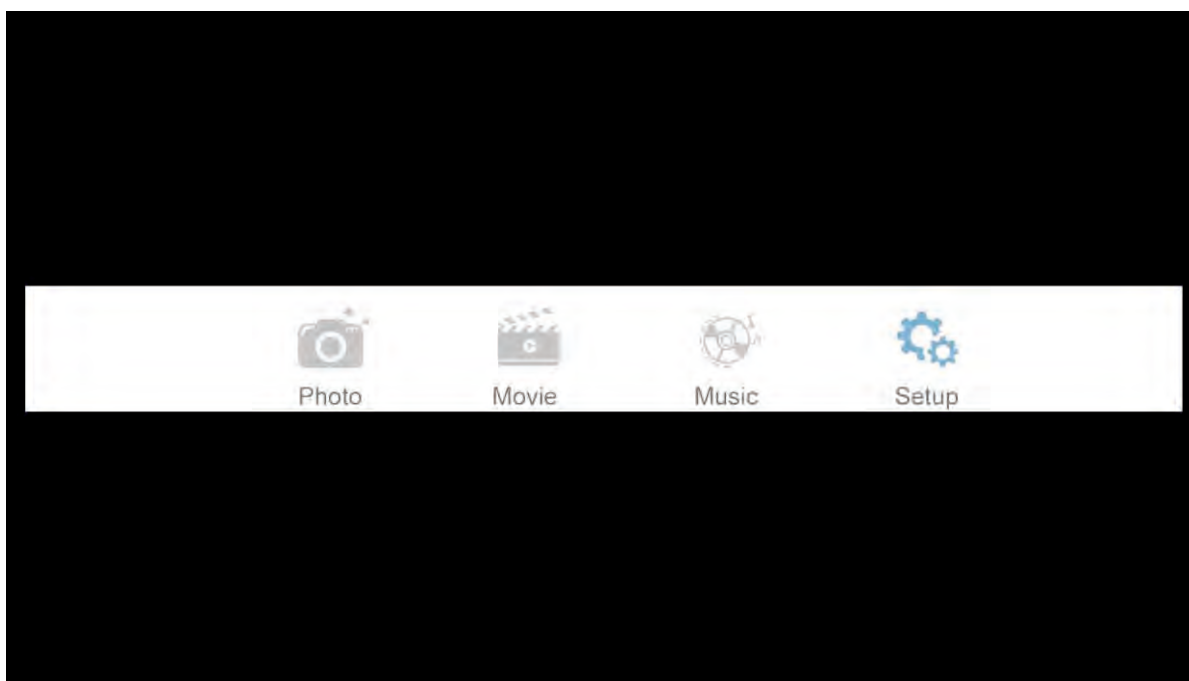

Press ▲/▼ button to select the option, and then Press ◀/▶ button to select on or off.

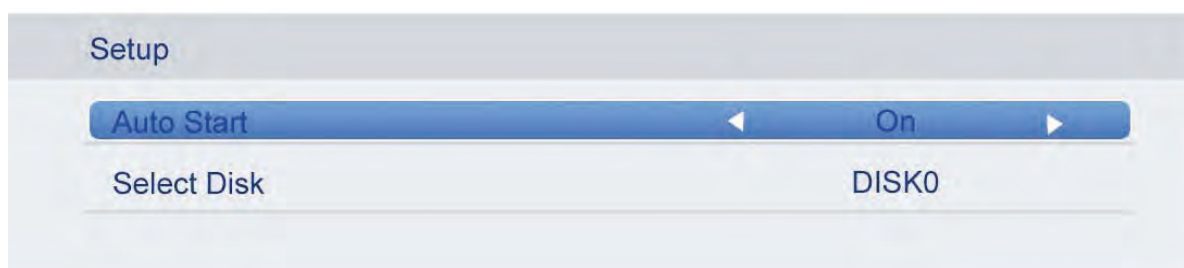

## 6. Troubleshooting

Carry out the problem solving measures described in the following section before contacting customer support. Turn off the device immediately as soon as you suspect a malfunction and unplug the power plug. Do not attempt to repair the device yourself.

SYMPTOM	CHECK ITEM
LCD screen stays dark.	Make sure the unit is turned on and the connections are correct. Make sure the power adapter is correctly connected.
There is no sound.	Make sure the system connection is correct. Make sure the power of speakers is turned on.
There is no picture or picture moves up and down unsteadily.	Check if the connections with the external AV signal source are correct. Correctly set the items in the picture menu. Check if the video type input signal is not corresponding to the unit. Make sure the unit is turned on and in correct video type.
The remote control does not work.	Make sure there are no obstructions between the remote control and the unit. Make sure the remote control is pointing at the unit. Make sure the batteries are inserted and the polarity is correct. Make sure the batteries are not exhausted. Replace the exhausted battery.

### Other Notes:

Static or other external interference may cause the TV to behave abnormally. If this occurs, unplug the power supply cord from the outlet and plug it in again to reset the player. If the problems persists, then please disconnect the power and consult a qualified technician.

## NOTICE CONCERNING RECYCLING



Your product is designed and manufactured with high quality materials and components which can be recycled and reused.

This symbol means that electrical and electronic equipment, at their end-of-life, should be disposed of separately from your household waste. Please dispose of this equipment at your local community waste collection/ recycling centre.

In the European Union there are separate collection systems for used electrical and electronic products. Please help us to conserve the environment we live in!

## DECLARATION OF CONFORMITY

This product complies with the requirements of the directives

EMC Directive 2014/30/EU

Low Voltage Directive 2014/35/EU

ErP Directive 09/125/EC

RoHS2 Directive 11/65/EU

### EXCLUSIVE IMPORTER IN GREECE:

#### **AMIRIDIS - SAVVIDIS S.A.**

87A, 17th November Str, 55535,  
Pylea, Greece

T: +302310944944 | F: +302310944940

web: [www.amiridis-savvidis.gr](http://www.amiridis-savvidis.gr)